

CLASSIC SKYSCRAPERS

INSTRUCTIONS FOR BUILDING THE COMPLETE CITY



JEFF FRIESEN

HOW TO USE THIS BOOK

In the pages ahead, you'll find instructions for building the entire Classic Skyscrapers city, including its heavy base of stratified geology. Big journeys are best broken into small chunks, so the instructions are divided into sections for the city's seven buildings, its bridge, the river barge, and the base.

You are free, of course, to use the buildings separately, or to incorporate them as features in your own city build. You can also rearrange the buildings on a custom-made base of your own design. Modular freedom

is the essence of LEGO, and you are encouraged to make your own creative choices.

A good place to begin customizing is the base. Tall, thick bases have become a trademark of my builds, but reducing the base's thickness can save you a significant number of bricks and a fair amount of work. This city's base measures 22 × 22 studs, but it can be expanded however you like.

Happy building!









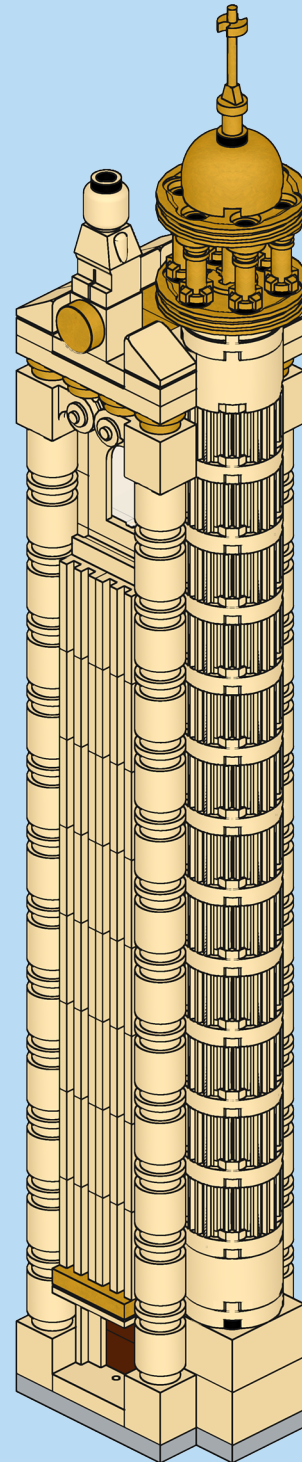

















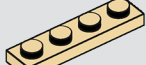
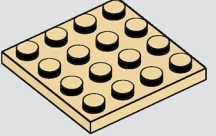
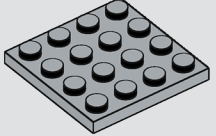
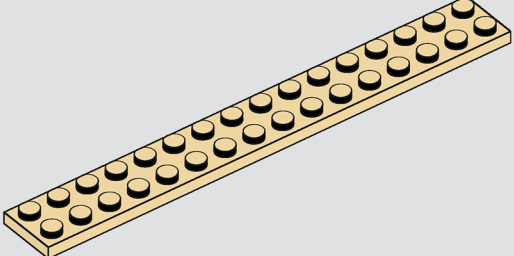





TABLE OF CONTENTS

BUILD 1: CLOUD CASTLE	4
BUILD 2: BRICKWORKS	16
BUILD 3: GRAYSTONE TOWER	26
BUILD 4: THE SHINING GATE	40
BUILD 5: GOTHIC HEIGHTS	60
BUILD 6: GOLDEN TOAD BANK	68
BUILD 7: CORNERSTONE COMMONS	76
BUILD 8: BRICKWELL MANOR	84
BUILD 9: RIVER BARGE	90
BUILD 10: THE BASE	94
BUILD 11: THE CITY	160

BUILD 1: CLOUD CASTLE

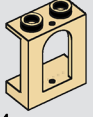

PARTS LIST

- | | | | | | | | |
|--|---|--|---|--|--|---|---|
| 
1x
30374 | 
4x
3005 | 
52x
3062 | 
2x
87087 | 
19x
4216 | 
4x
20310 | 
8x
11211 | 
12x
92947 |
| 
2x
3003 | 
12x
3003 | 
1x
553 | 
1x
3941 | 
1x
68013 | 
2x
60601 | 
6x
64567 | |
| 
1x
85863 | 
1x
90540 | 
48x
4073 | 
10x
4073 | 
1x
3023 | 
1x
3023 | 
2x
15573 | 
2x
32028 |
| 
14x
4032 | 
3x
3022 | 
2x
3710 | 
1x
3031 | 
1x
3031 | | | |
| 
2x
4282 | | | | | | | |
| | | | | 
6x
54200 | 
2x
98138 | 
4x
3069 | 
32x
2412b |
| 
1x
15535 | 
2x
4185 | 
4x
90195 | | | | | |

1

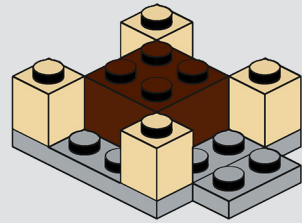
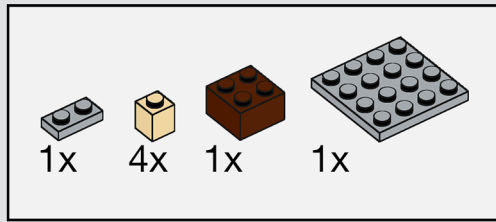

5

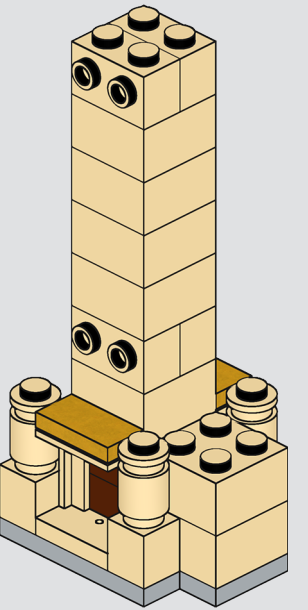
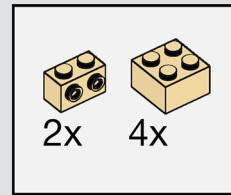

2

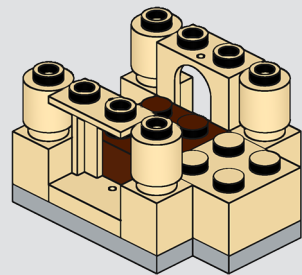
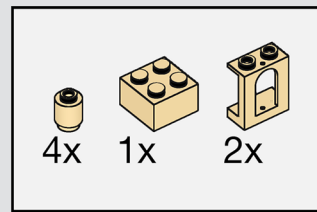

6

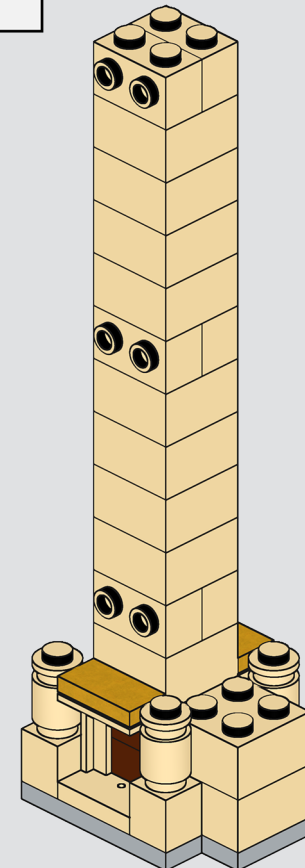
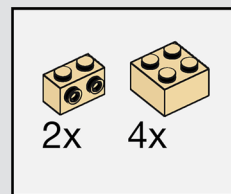

7

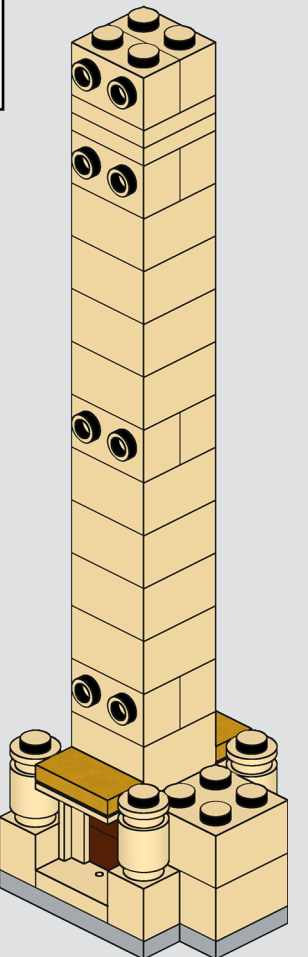
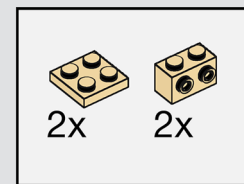

3

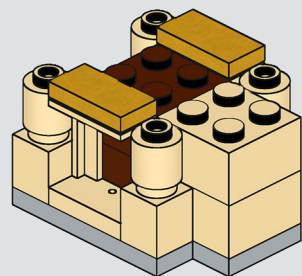
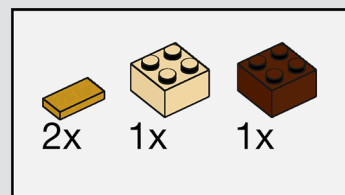

4

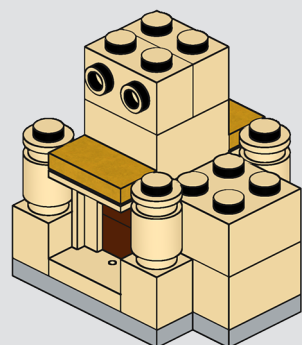
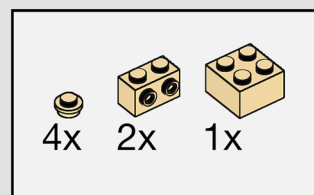

8

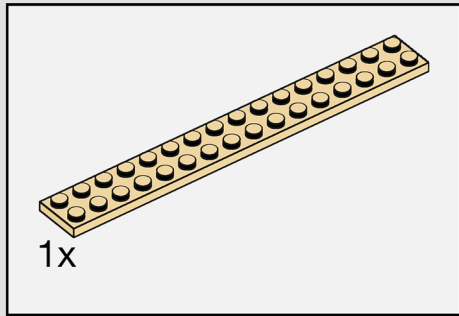

9

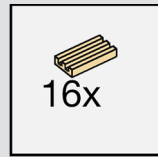

10

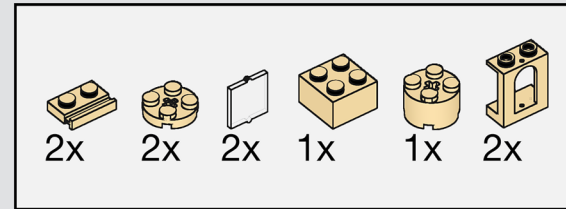

11

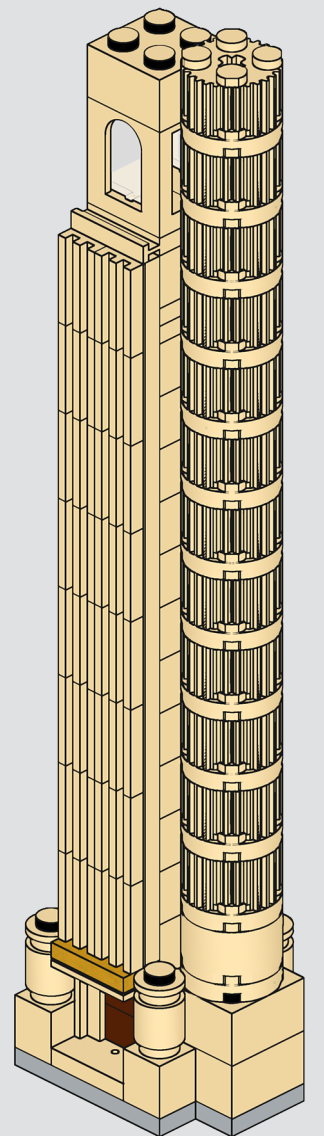
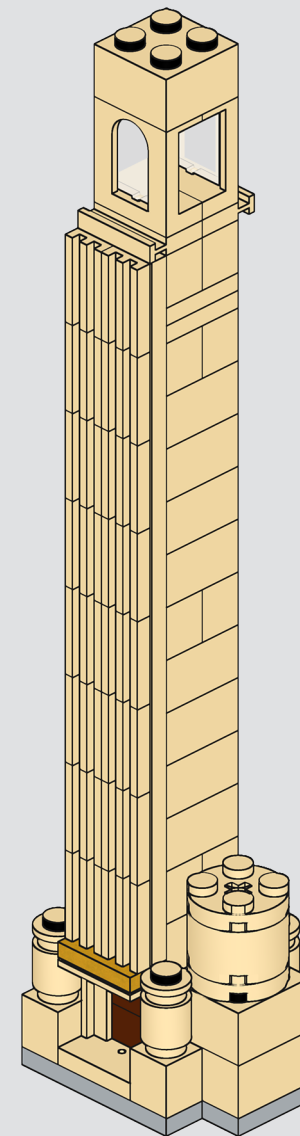
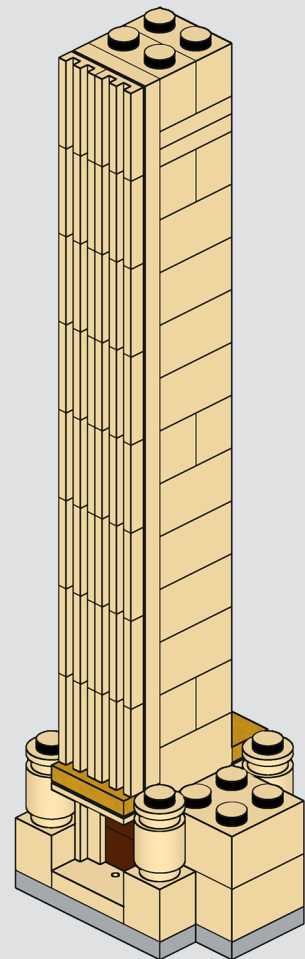
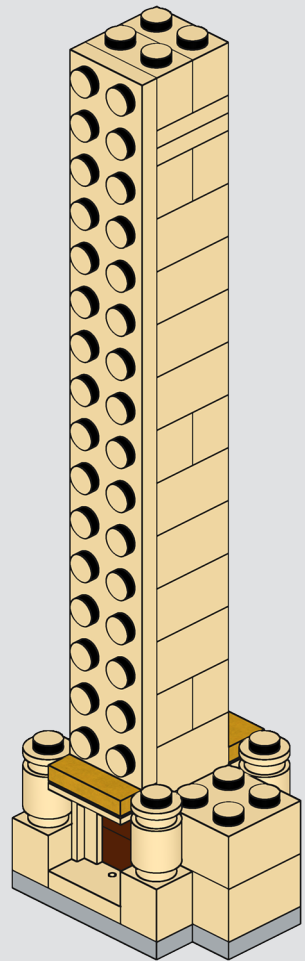
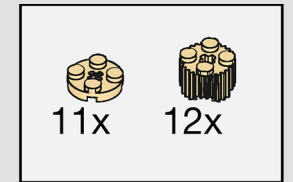

12

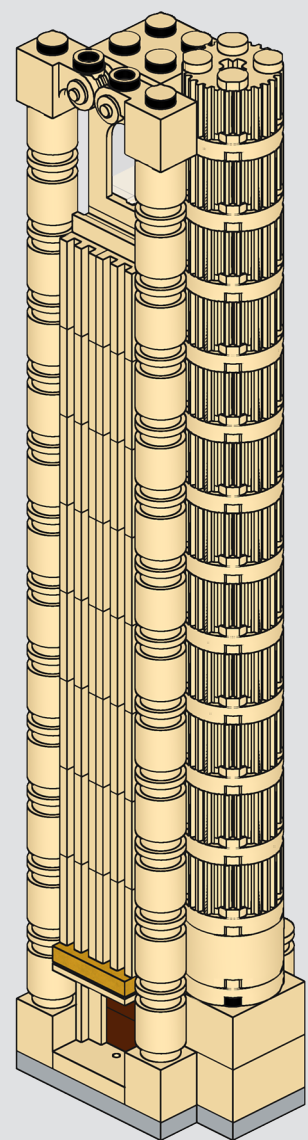
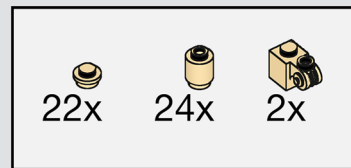

13

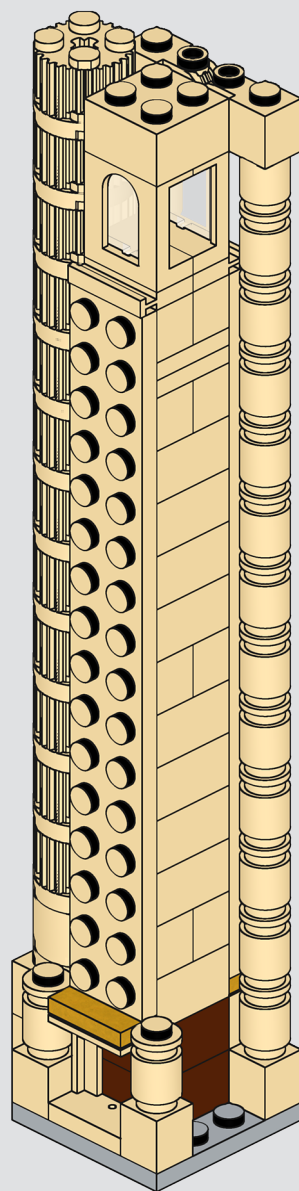
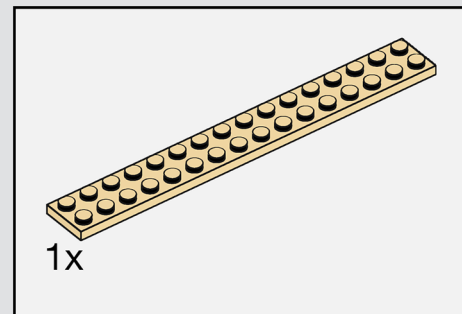

14

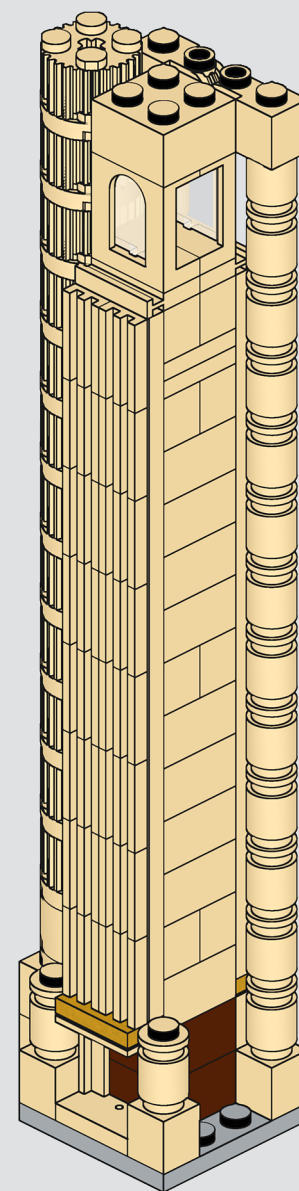

15

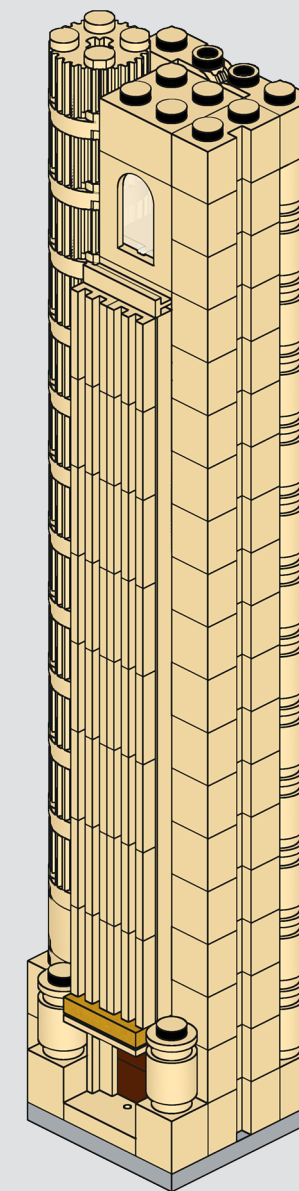
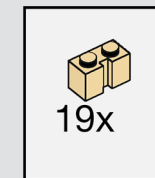

16

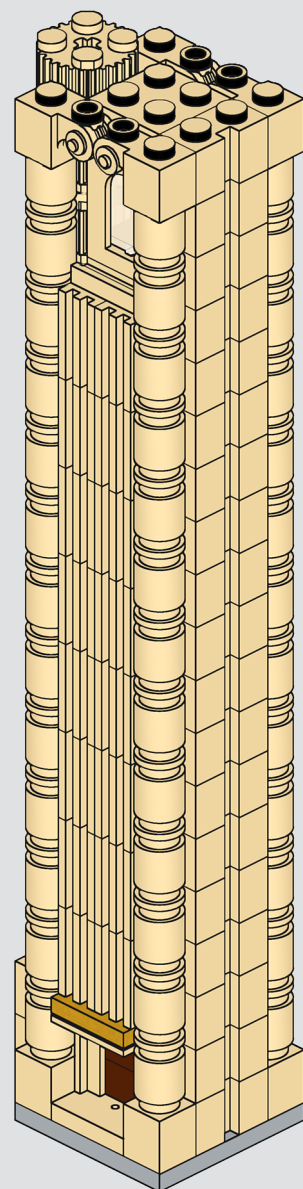
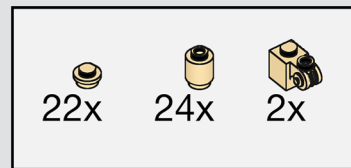

17

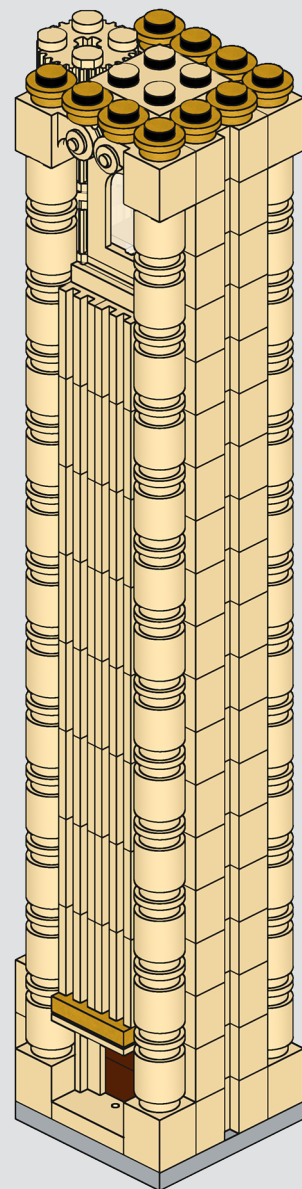
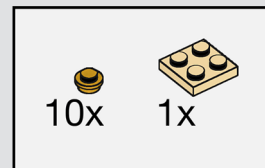

18

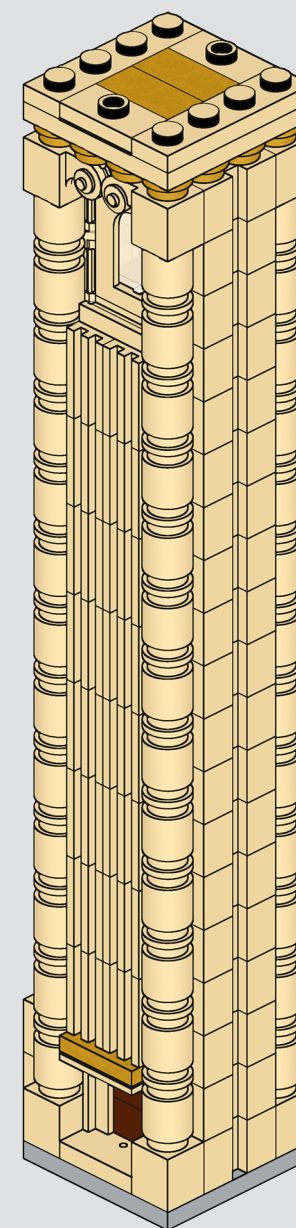
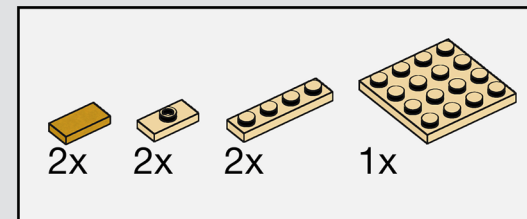

19

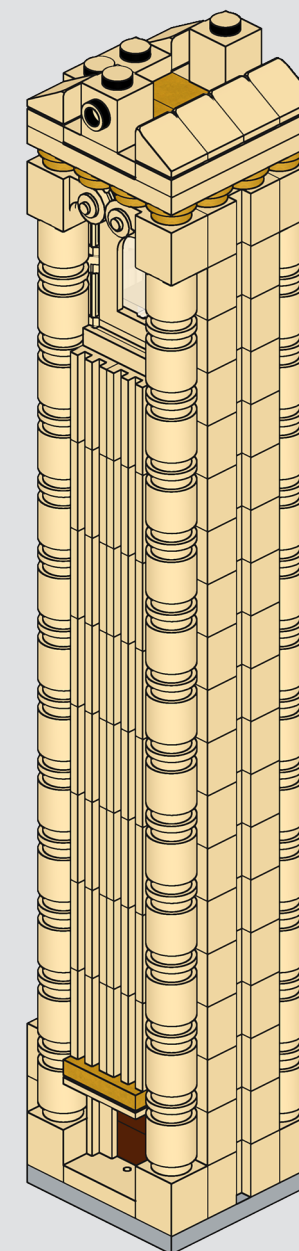
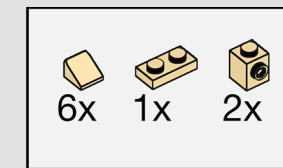

20

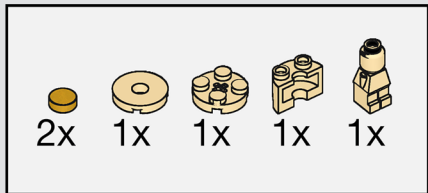

21

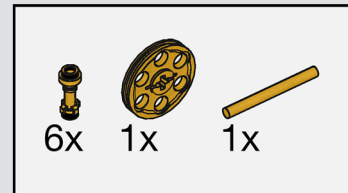



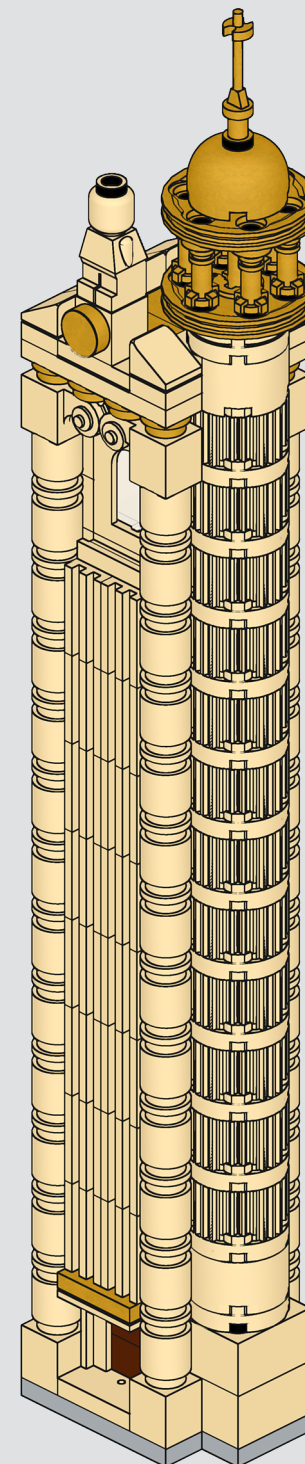
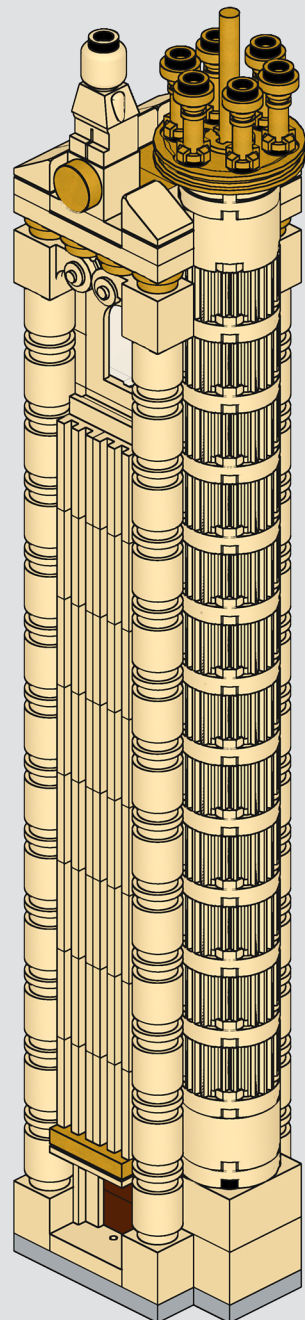
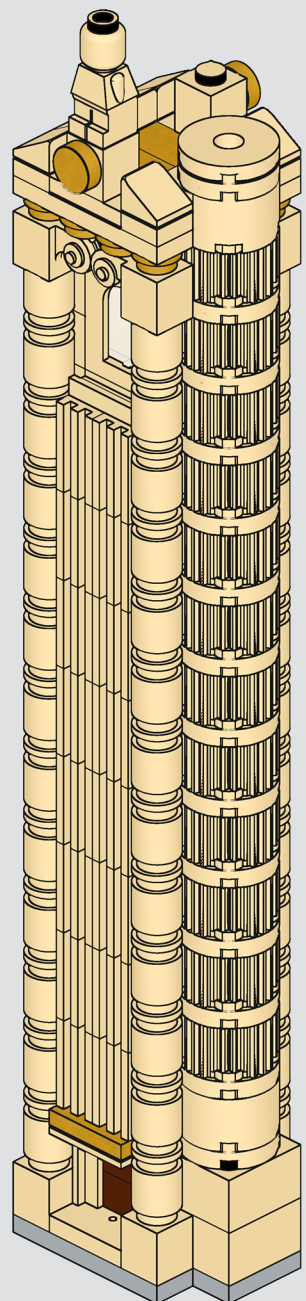
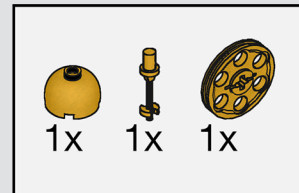



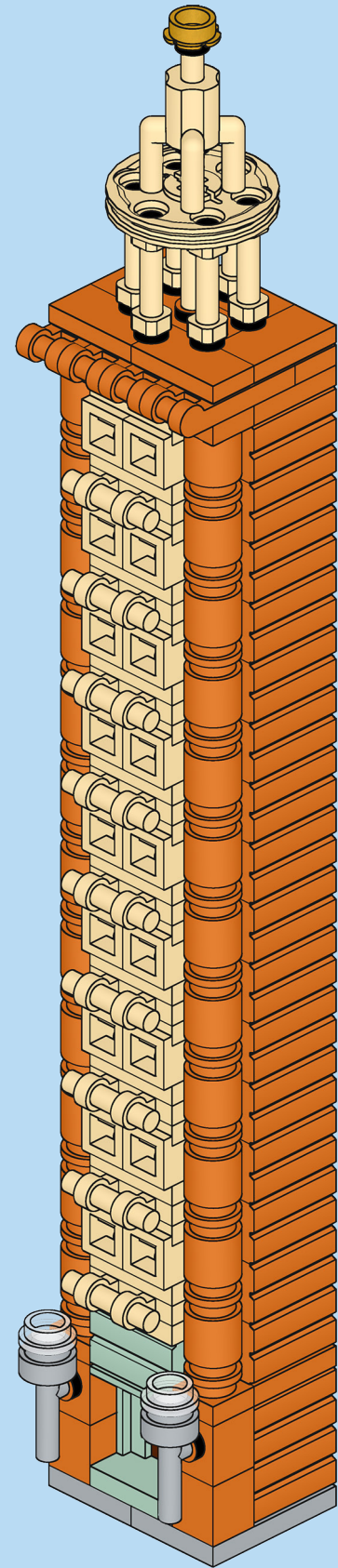



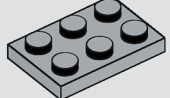







22

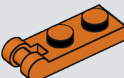
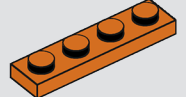
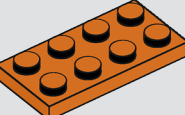

BUILD 2: BRICKWORKS

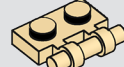
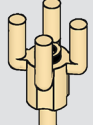
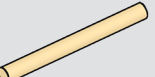

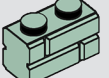
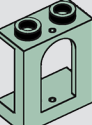
PARTS LIST

- | | | | | | | |
|---|--|--|---|--|--|--|
| 
2x
86208 | 
2x
3021 | 
2x
3004 | 
24x
4073 | 
2x
3024 | 
24x
3062 | 
2x
3005 |
| 
2x
87087 | 
1x
15573 | 
5x
3069 | 
38x
98283 | 
4x
60478 | 
2x
3710 | |
| 
2x
3020 | 
50x
4070 | 
19x
3023 | 
6x
66909 | 
9x
2540 | 
1x
2566 | 
1x
30374 |
| 
1x
4185 | 
1x
98283 | 
1x
90195 | 
2x
4073 | 
1x
24866 | | |

1

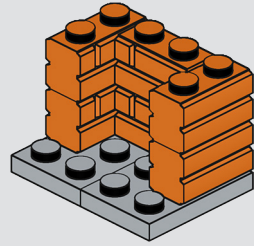
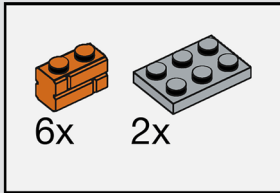

5

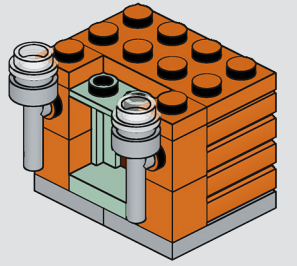
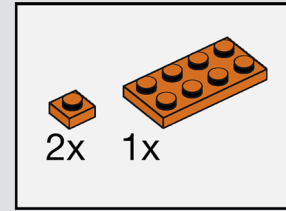

2

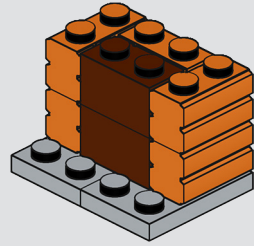
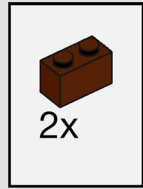

6

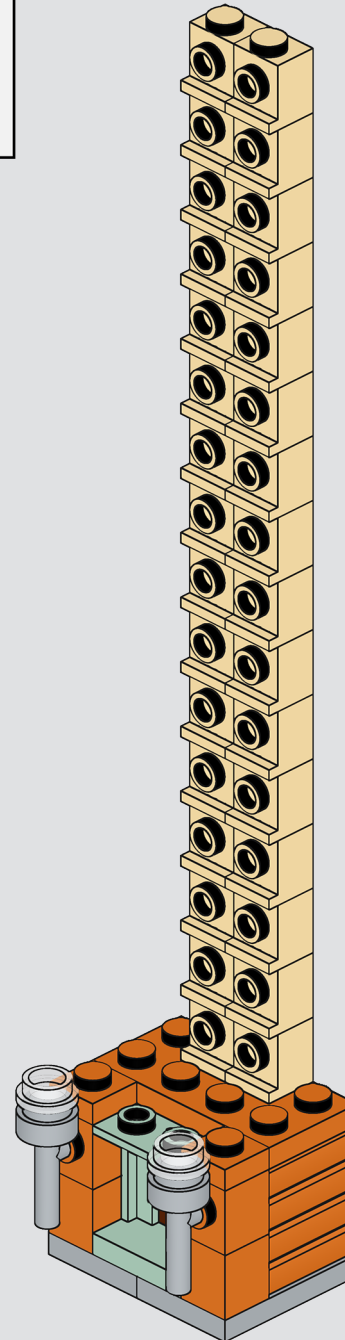
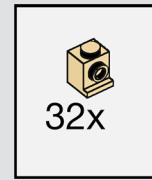

7

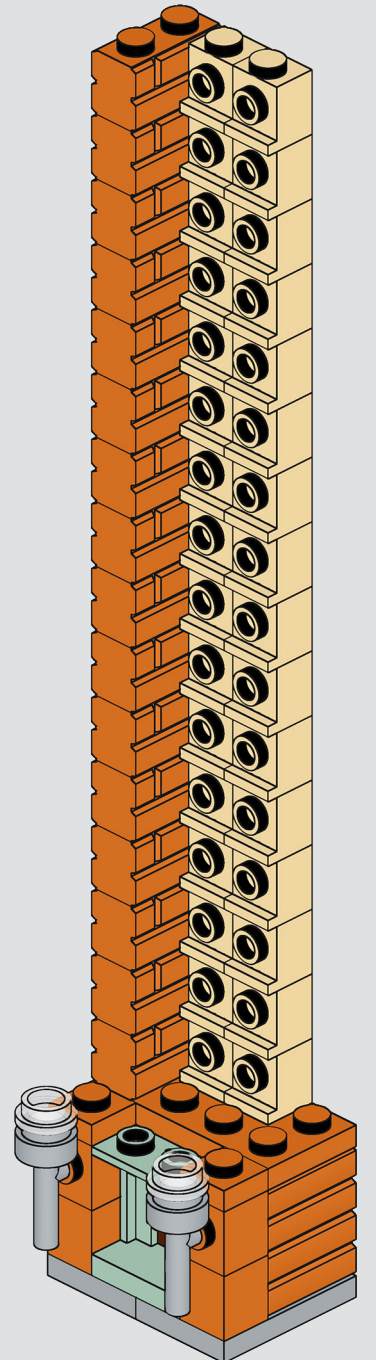
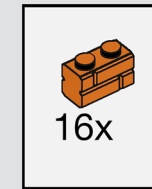

3

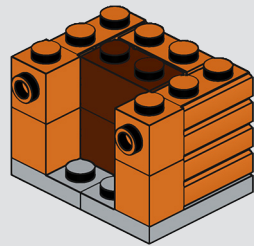
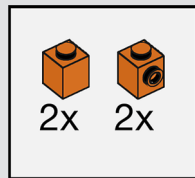

4

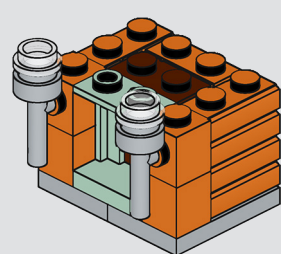
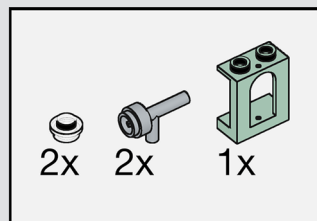

8

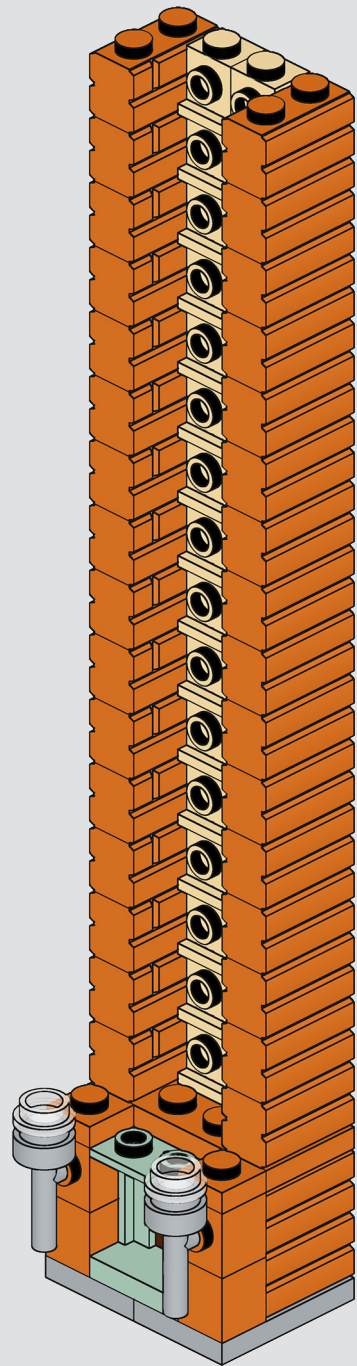
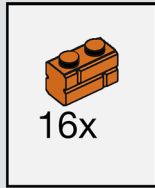

9

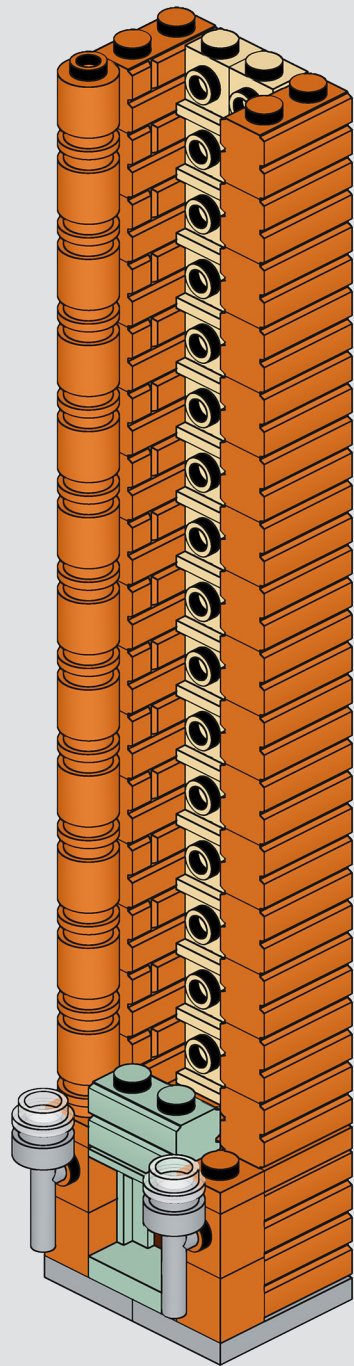
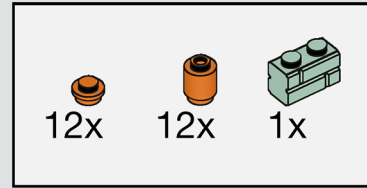

10

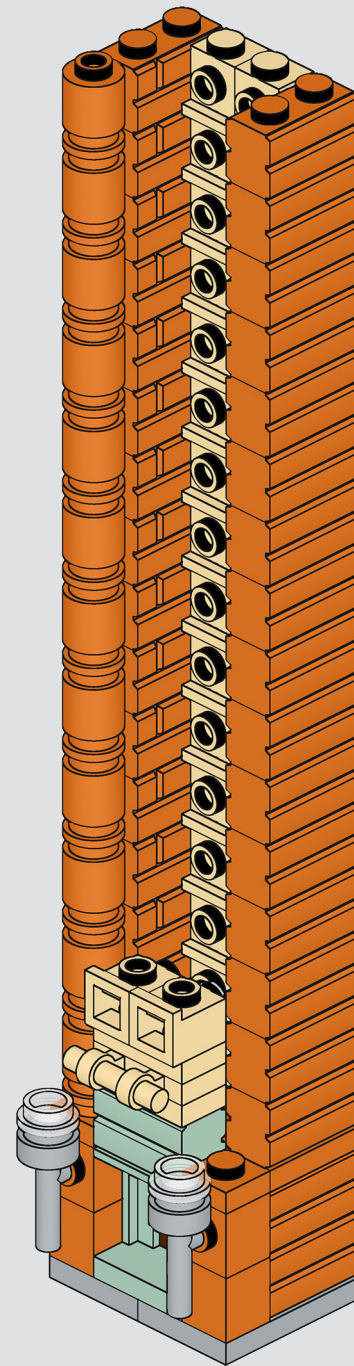
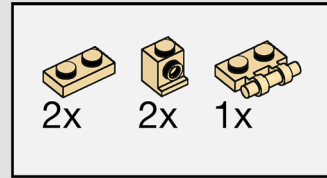

11

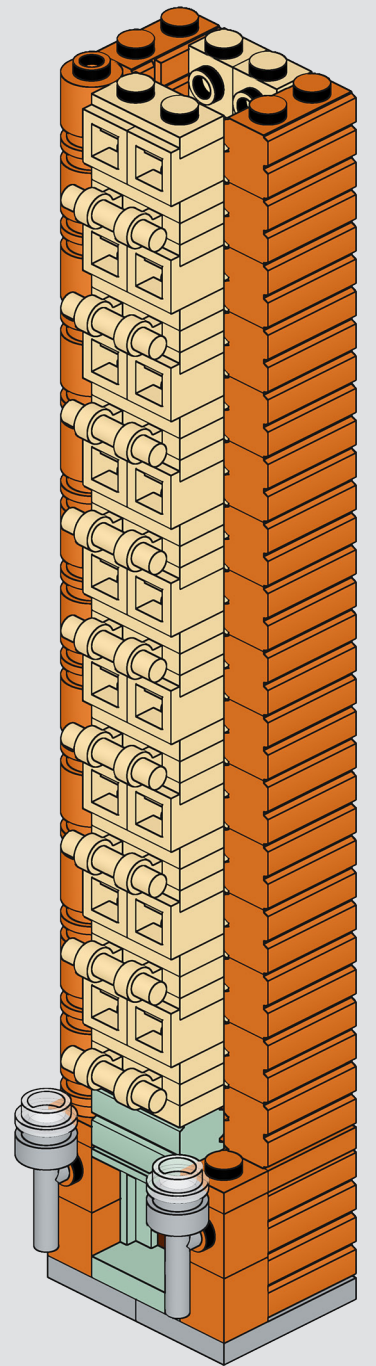
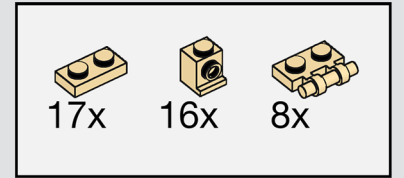

12

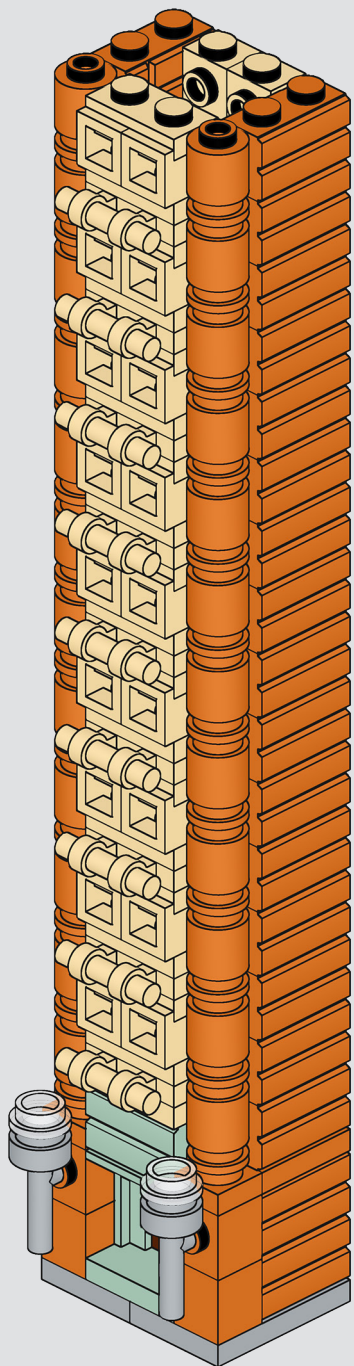
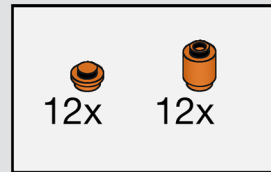

13

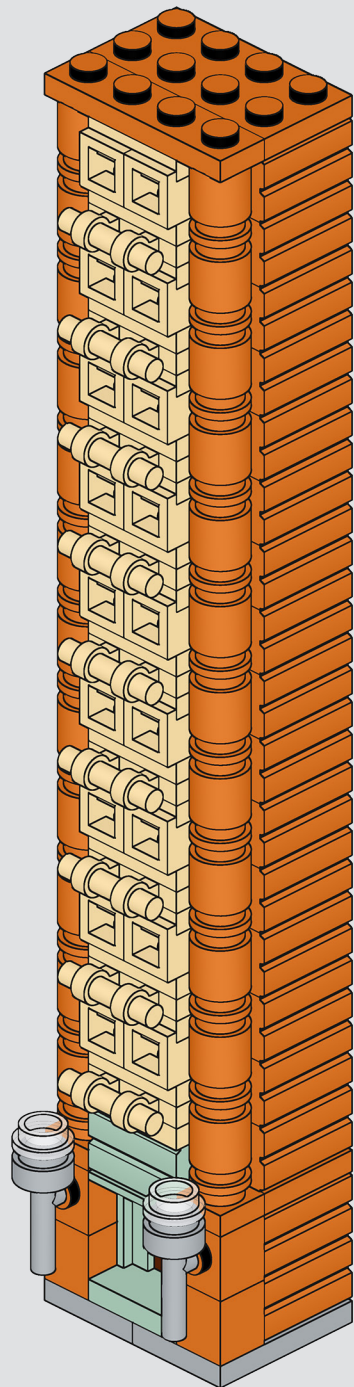
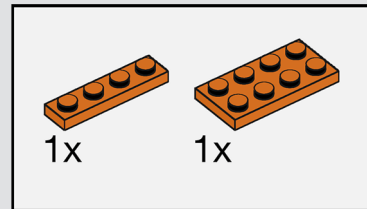

14

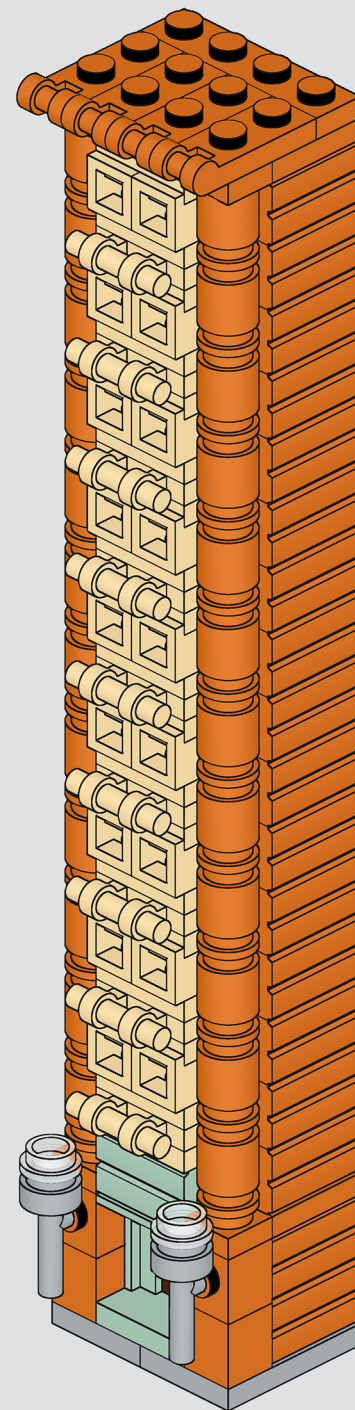
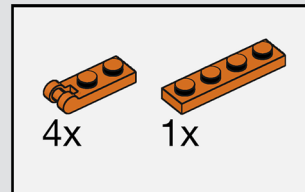

15

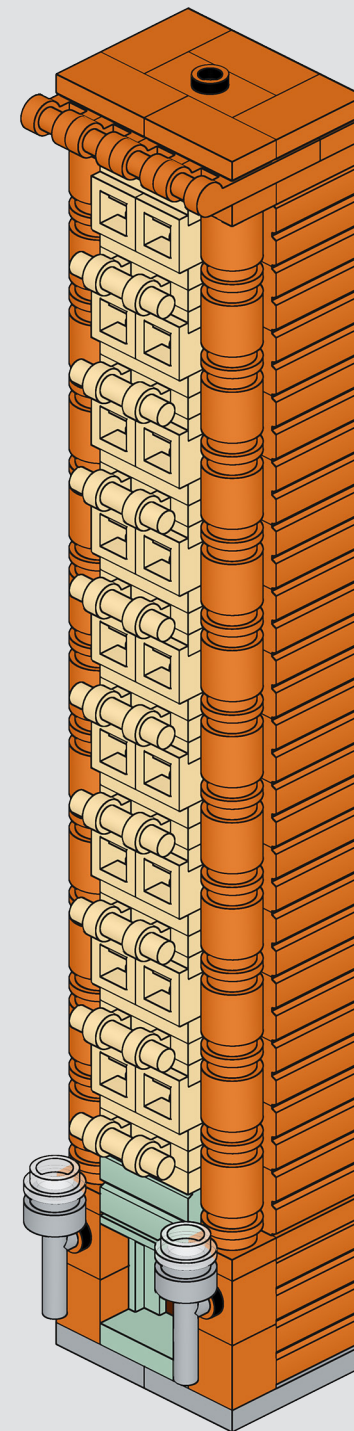
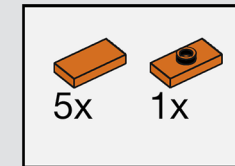

16

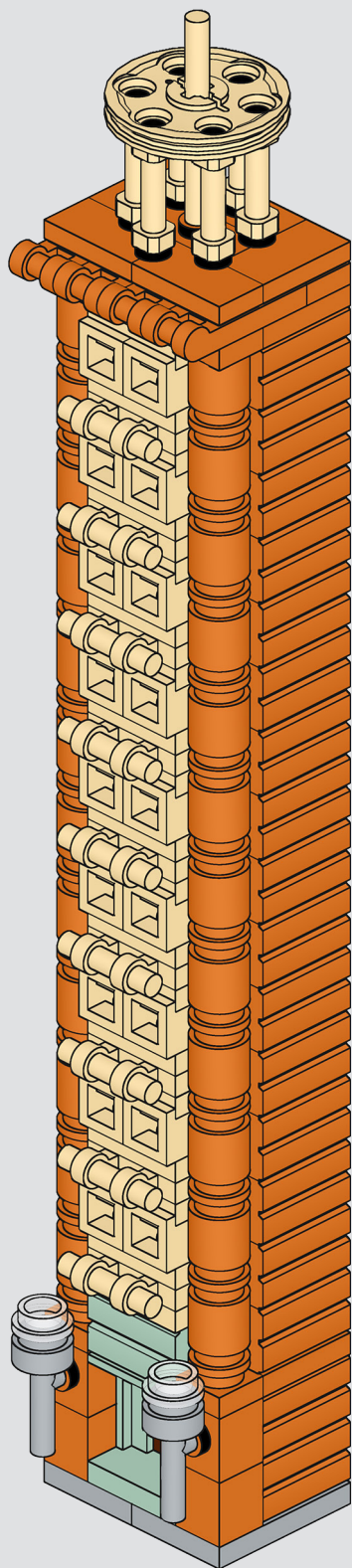
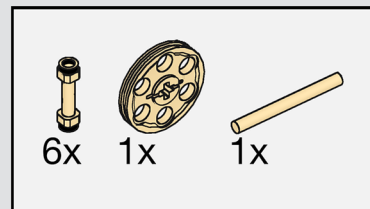



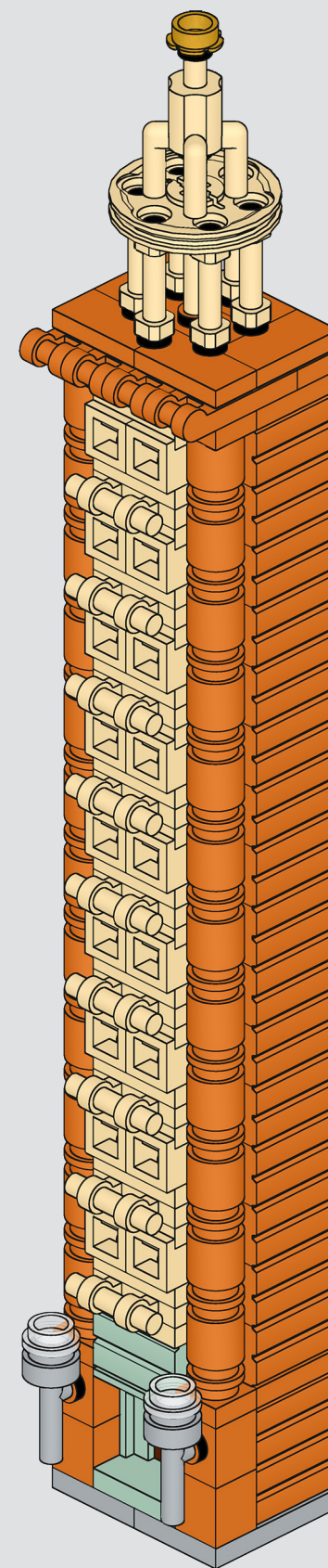
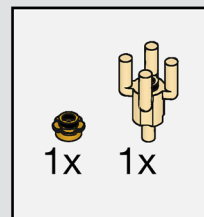



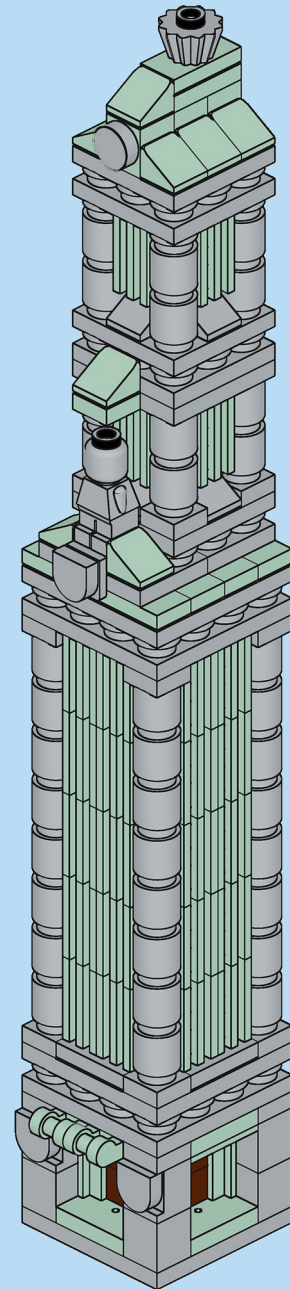













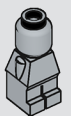

17

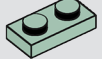
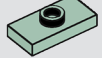
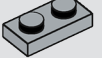
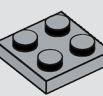
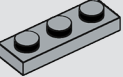
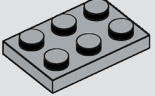
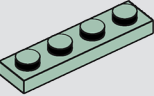

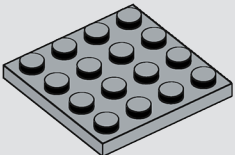
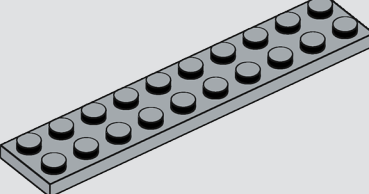
BUILD 3: GRAYSTONE TOWER

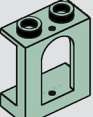

PARTS LIST

 1x 36841	 8x 3005	 2x 4070	 48x 3062	 2x 3005	 1x 87087	 2x 4733	 2x 3003
 10x 67329	 1x 79743	 1x 85863	 18x 3024	 52x 4073	 2x 26047	 4x 3023	
 9x 15573	 8x 3023	 4x 3022	 2x 3623	 2x 3021	 1x 3710		
 5x 11212	 5x 3031	 4x 3832	 10x 54200	 8x 54200			
 1x 98138	 3x 24246	 4x 3069	 48x 2412b	 4x 90195			

1

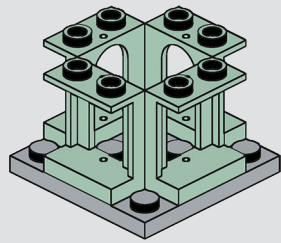
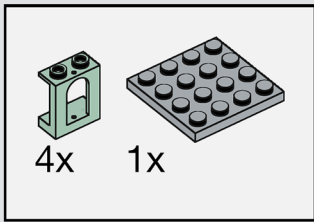

6

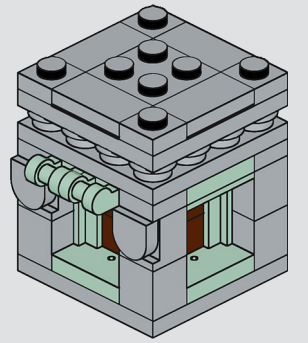
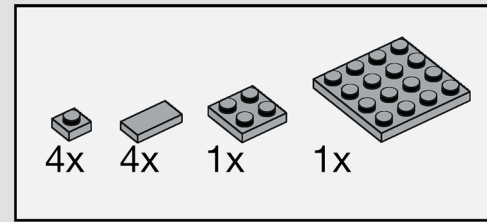

2

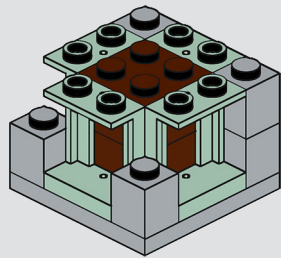
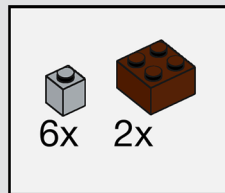

7

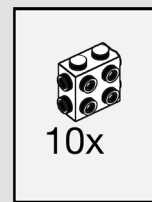

8

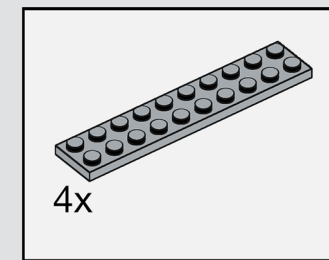

9

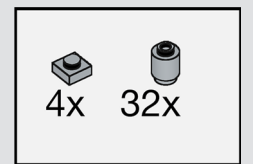

3

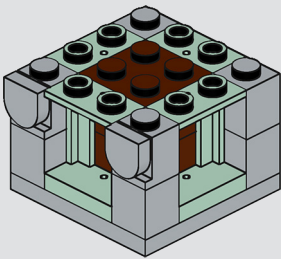
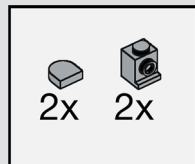

4

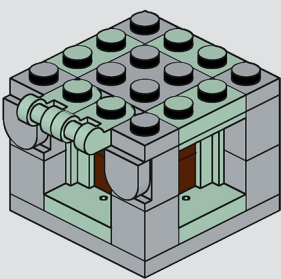
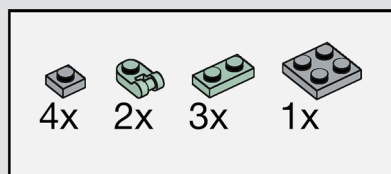

5

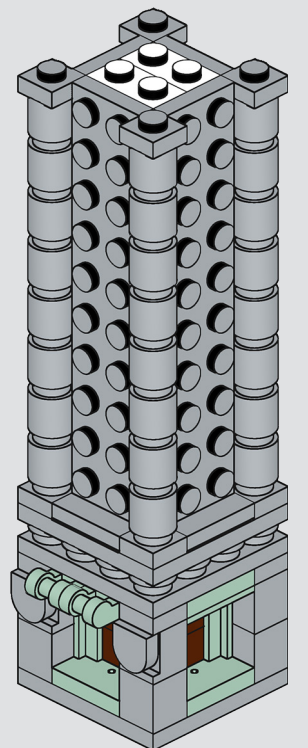
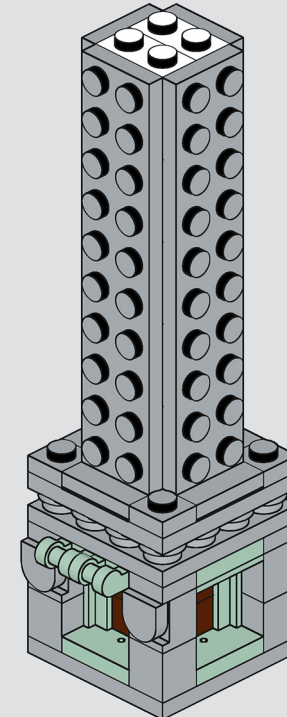
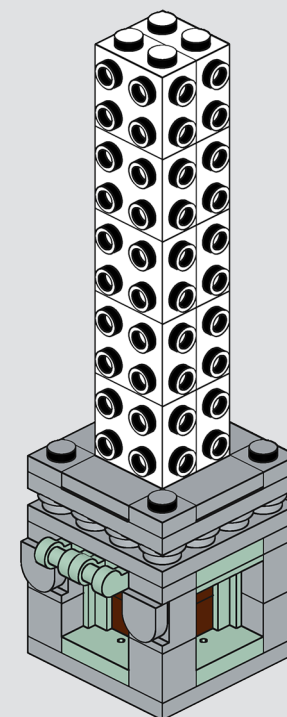
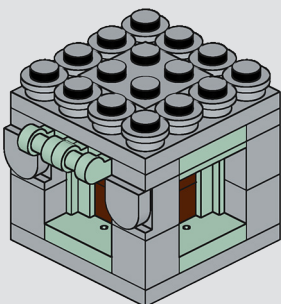
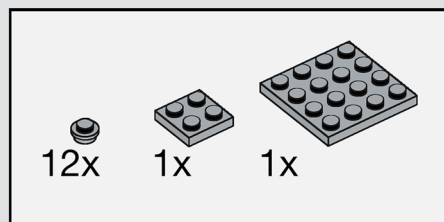

10

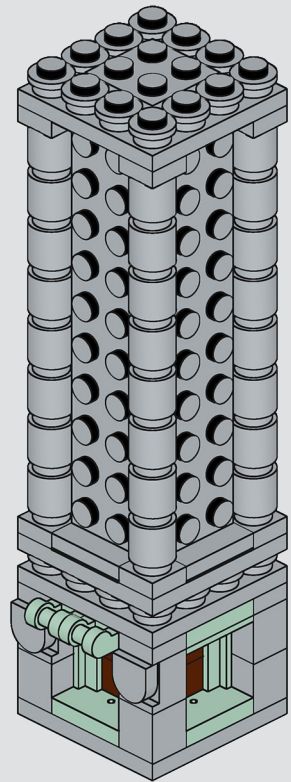
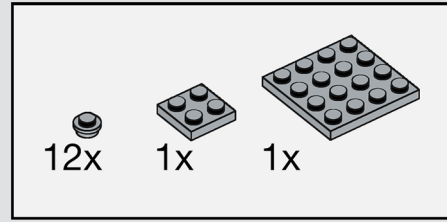

11

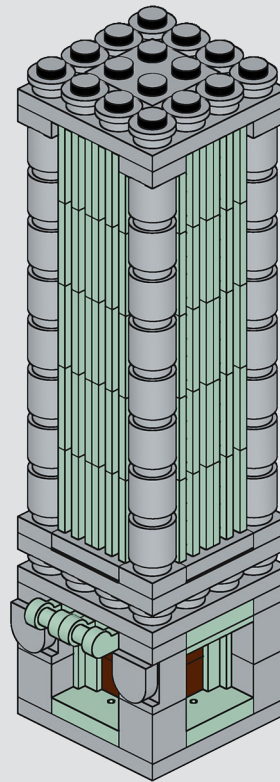
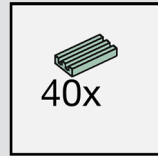

12

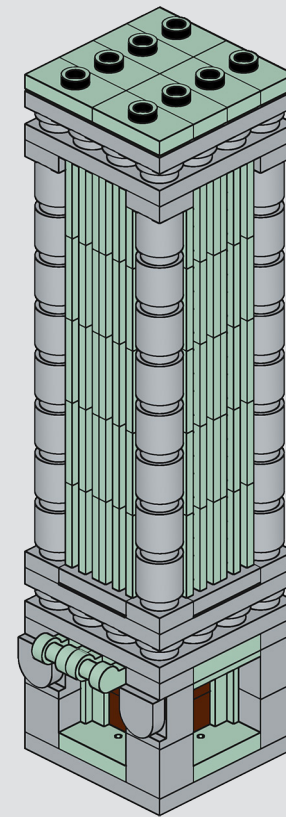
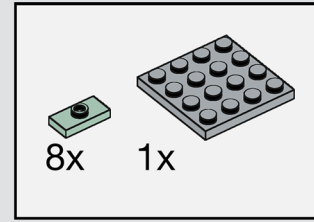

13

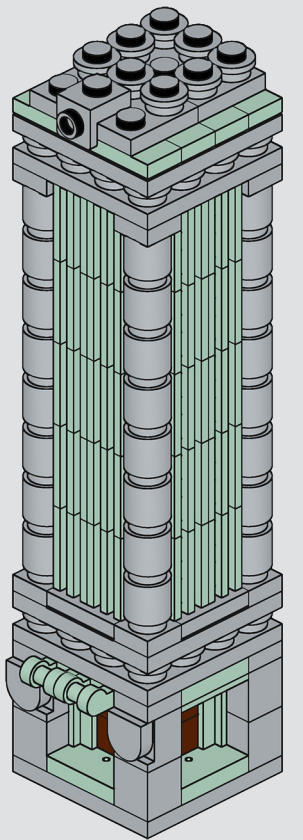
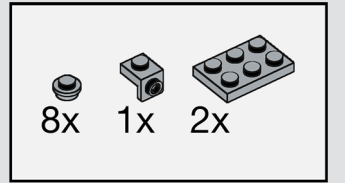

14

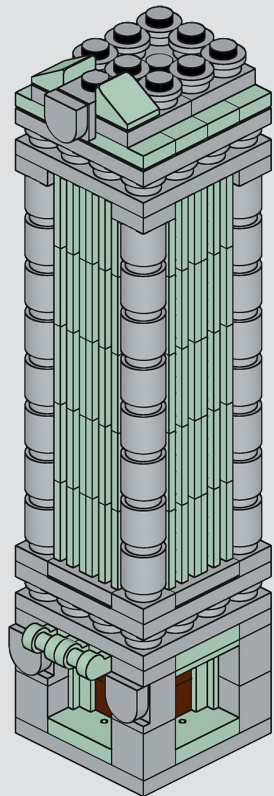
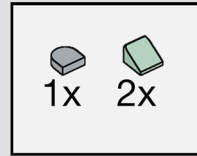

15

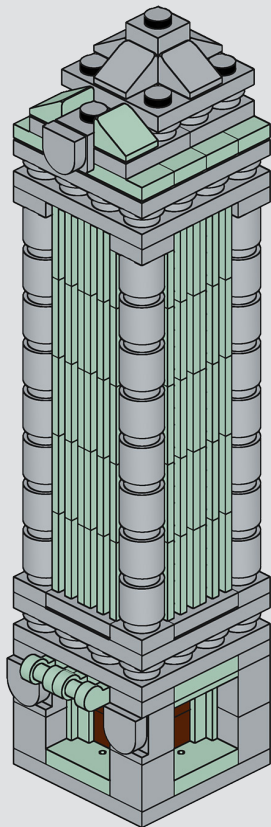
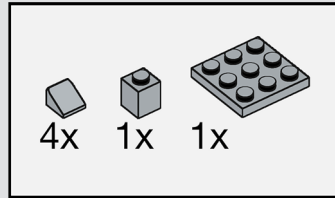

16

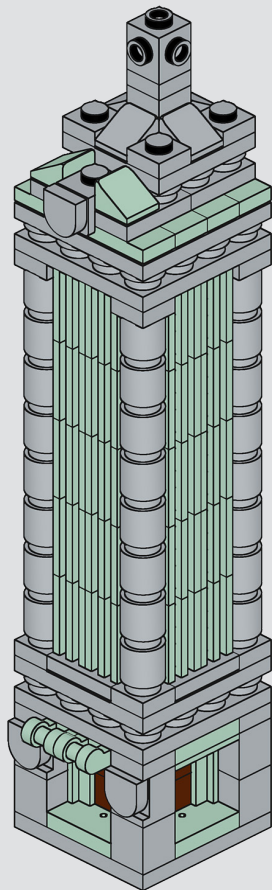
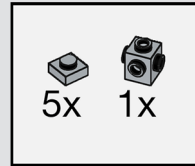

17

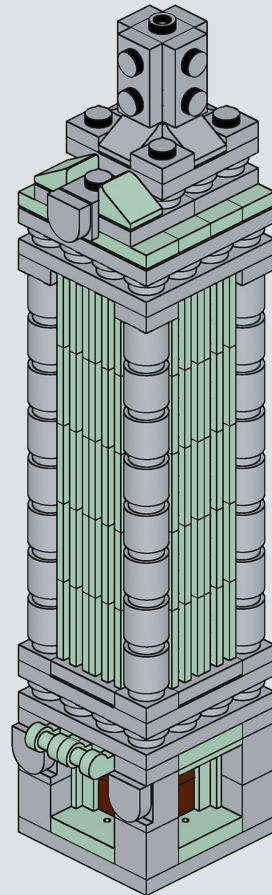
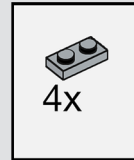

18

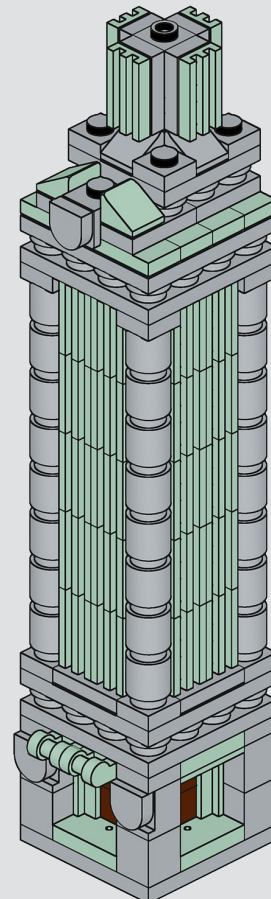
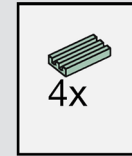

19

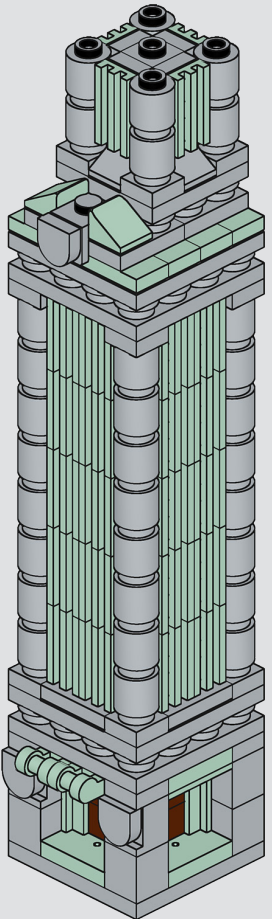
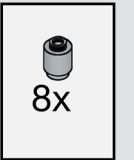

20

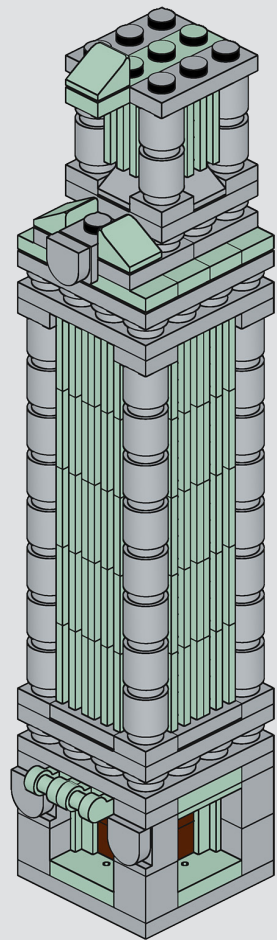
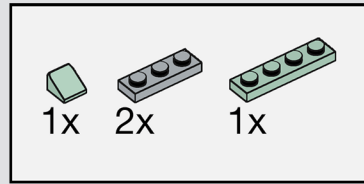

21

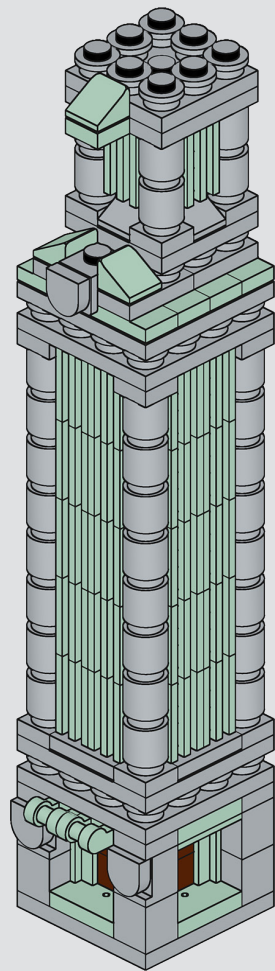
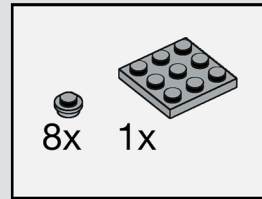

22

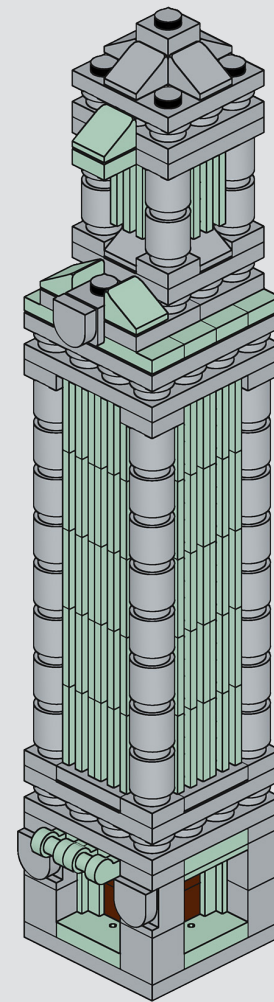
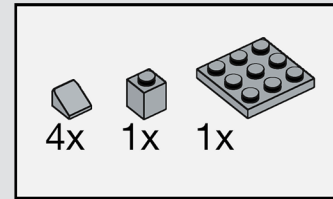

23

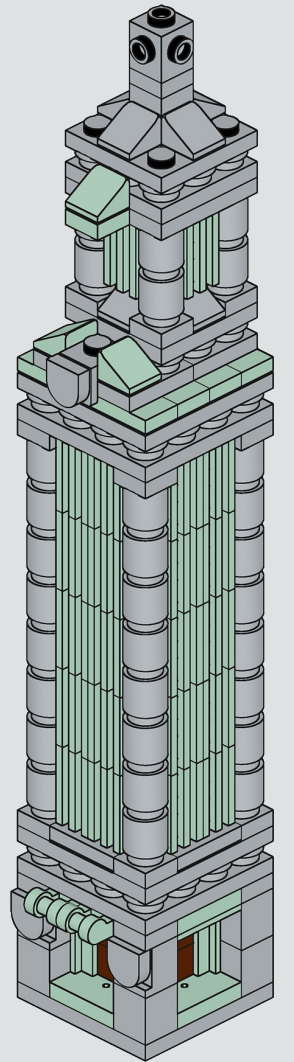
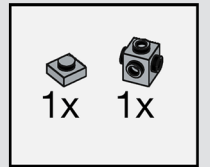

24

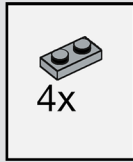

25

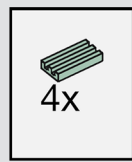

26

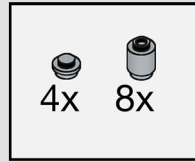

27

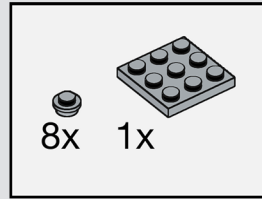

28

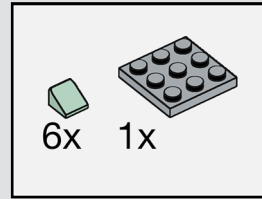

29

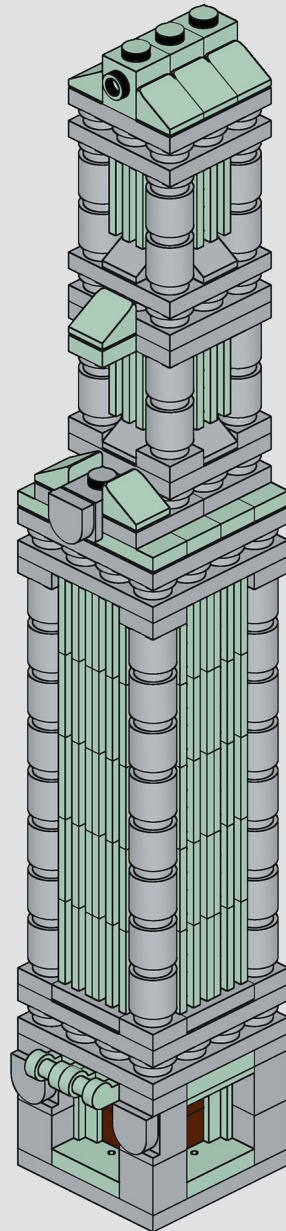
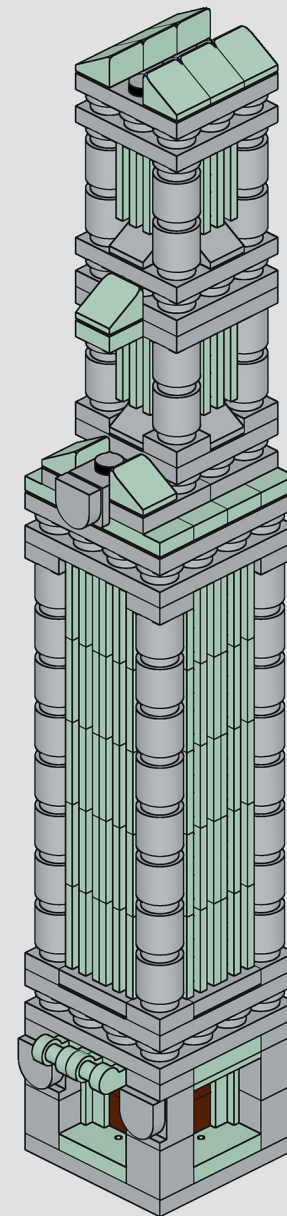
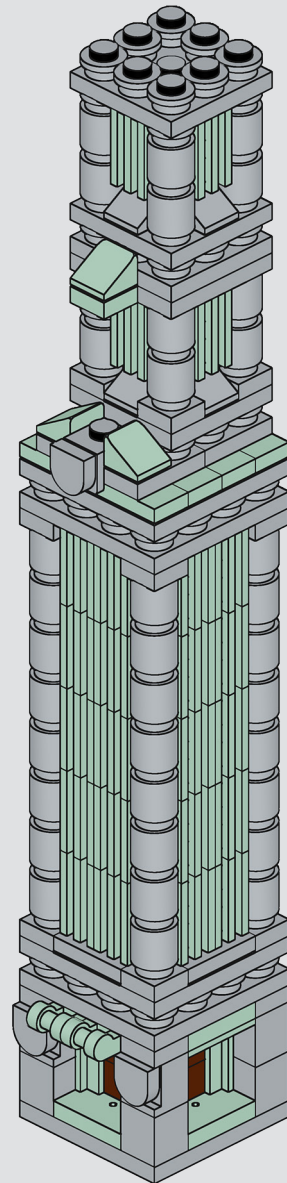
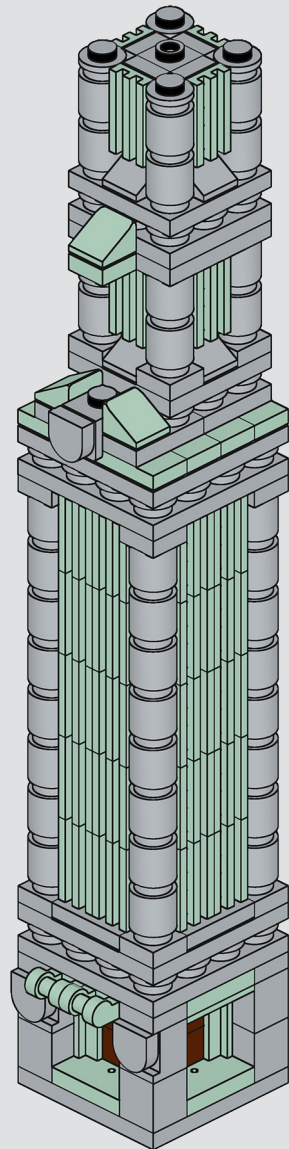
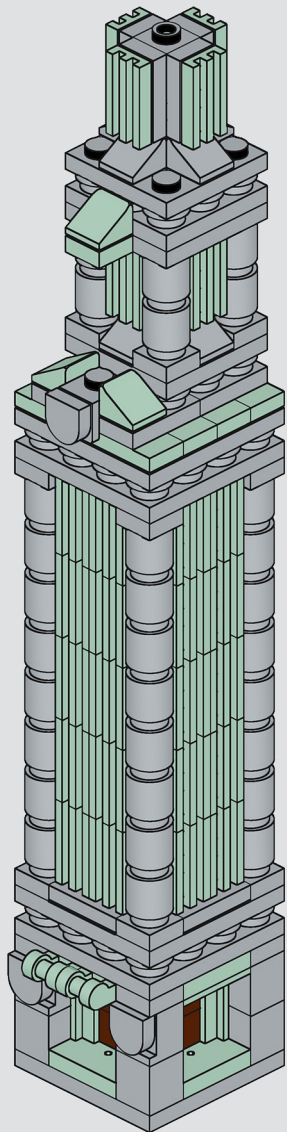
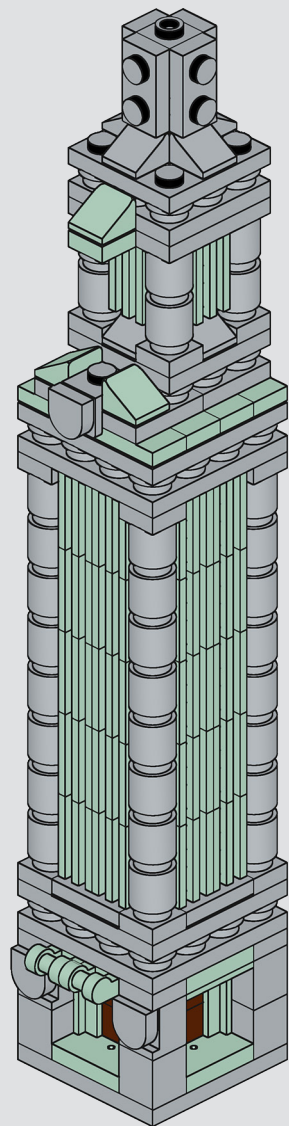
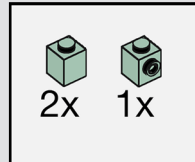

30

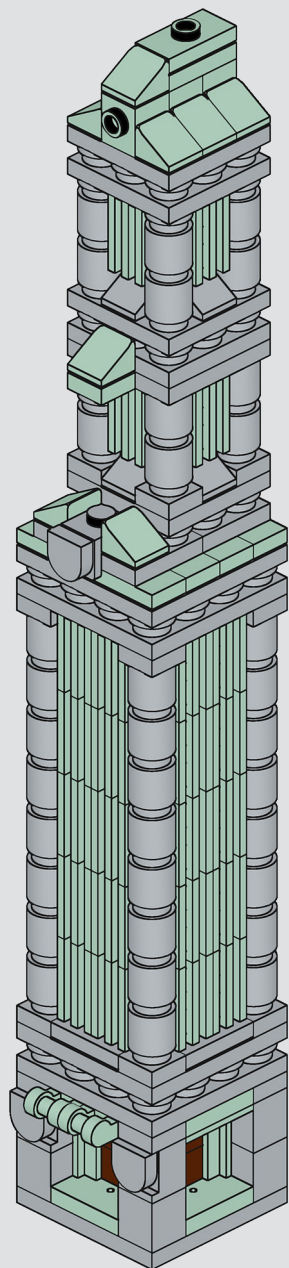
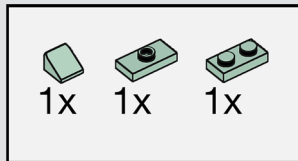

31

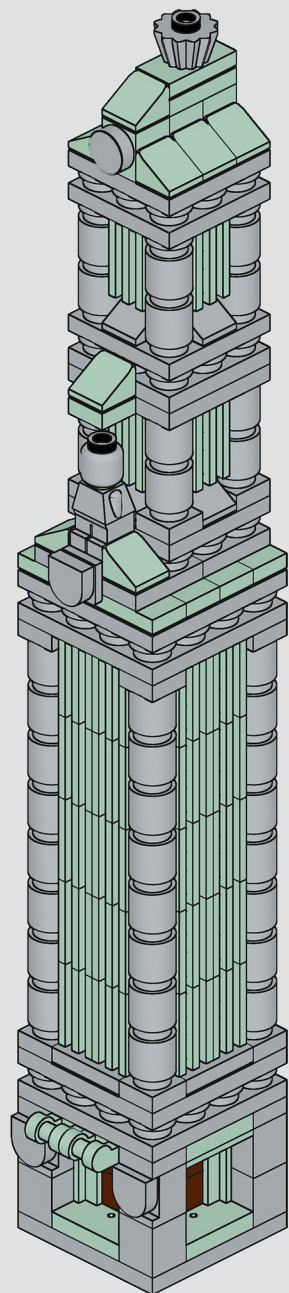
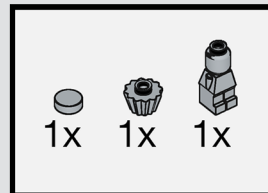

BUILD 4: THE SHINING GATE

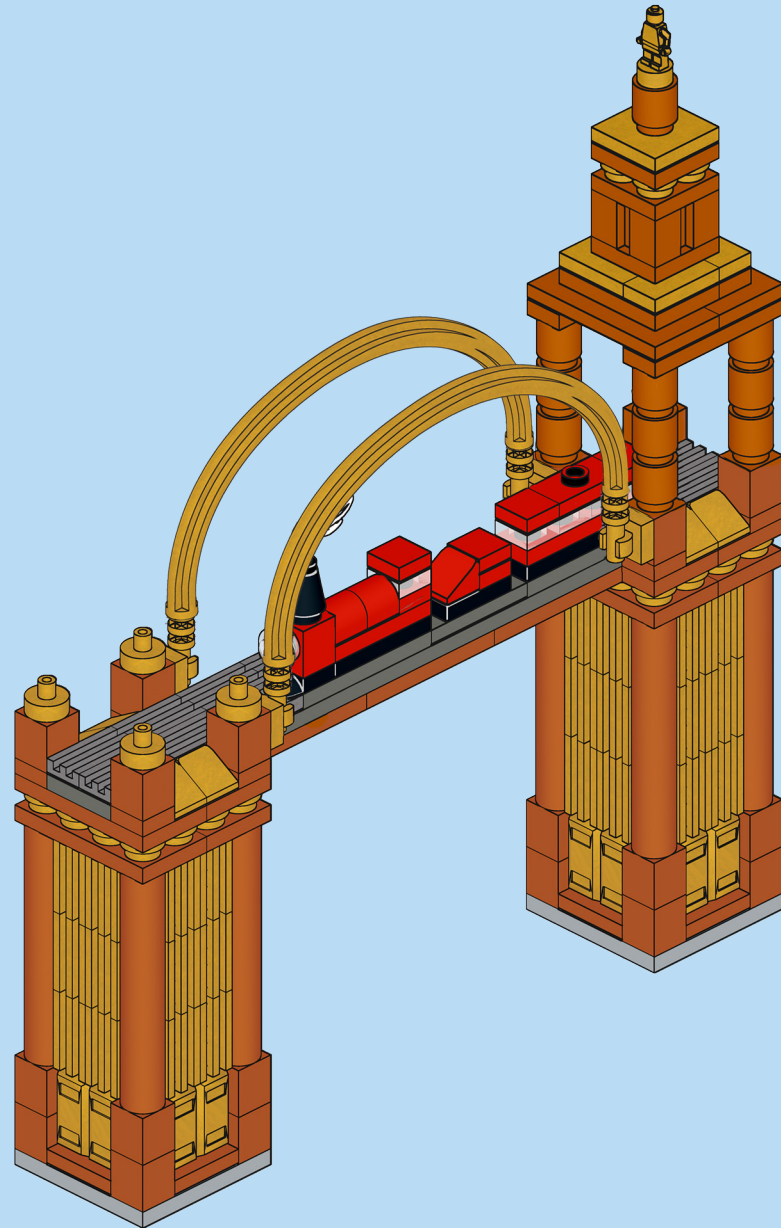

PARTS LIST

- 1x 4589b
- 1x 3023
- 1x 49668
- 1x 3623
- 1x 3710
- 2x 3022
- 1x 34103
- 1x 3623
- 1x 3710
- 1x 4282
- 4x 3022
- 2x 3031
- 1x 64647
- 4x 3070
- 2x 3024
- 2x 49307
- 1x 54200
- 1x 87087
- 1x 15573
- 1x 3623
- 1x 3710
- 9x 3024
- 13x 3062
- 12x 3005
- 4x 87087
- 8x 3069
- 3x 3022
- 1x 90258
- 1x 3623
- 1x 3021
- 2x 3710
- 2x 65509
- 11x 3020
- 8x 43888
- 16x 3020
- 32x 32952
- 1x 4073
- 5x 3024
- 15x 2412b
- 28x 4073
- 4x 20482
- 8x 54200
- 4x 15712
- 16x 99563
- 48x 2412b
- 4x 3069
- 1x 90398
- 1x 87580
- 2x 32202

1

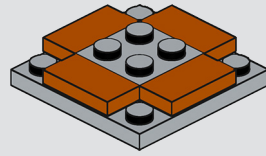
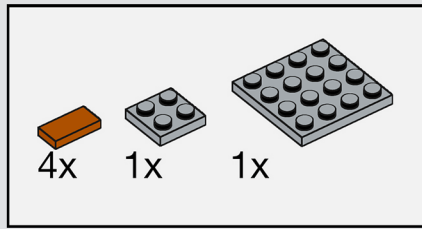

4

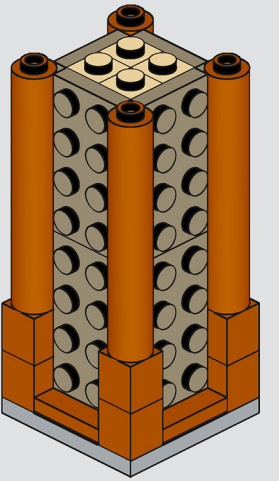
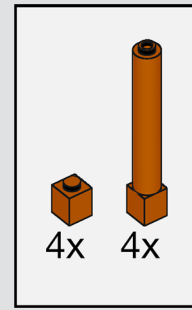

2

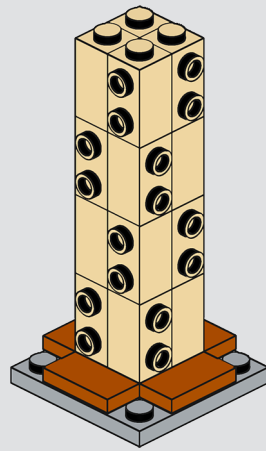
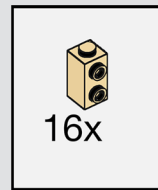

5

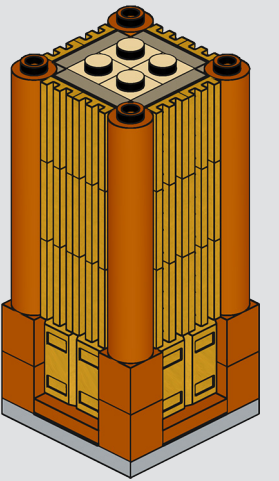
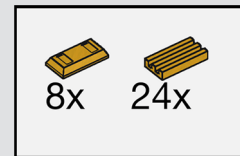

3

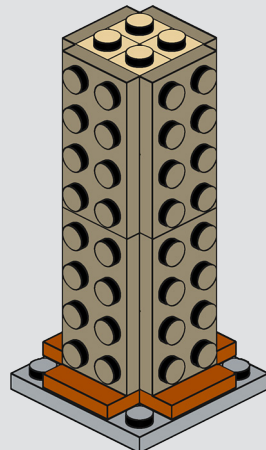
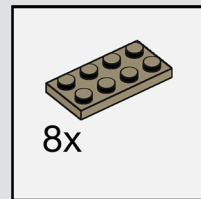

6

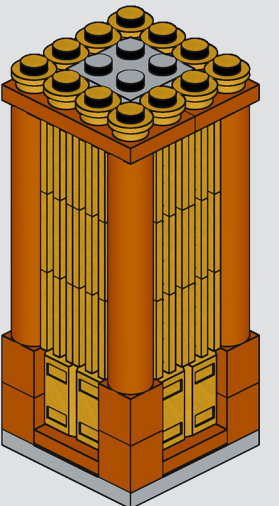
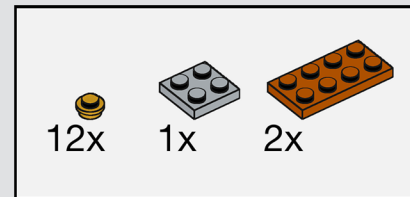

7

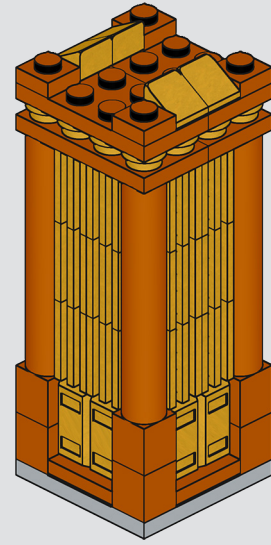
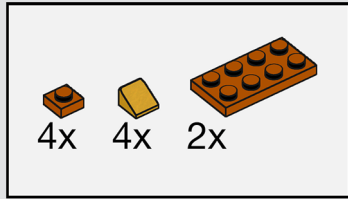

9

8

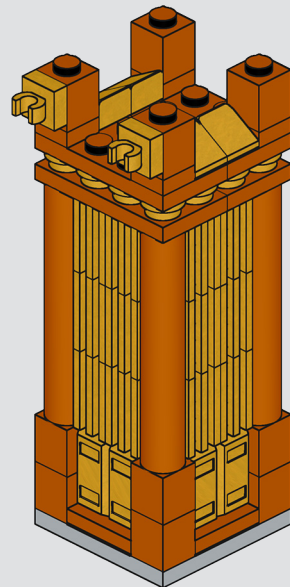
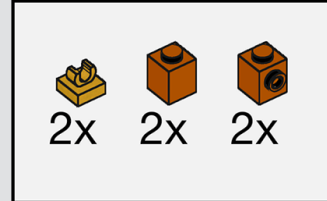

× 2

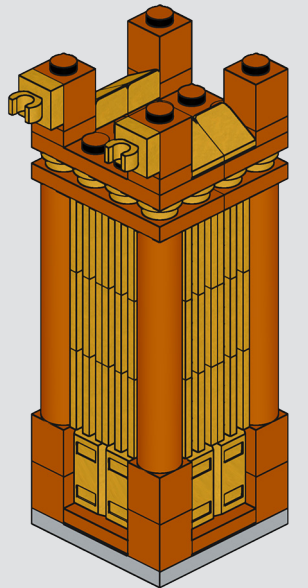
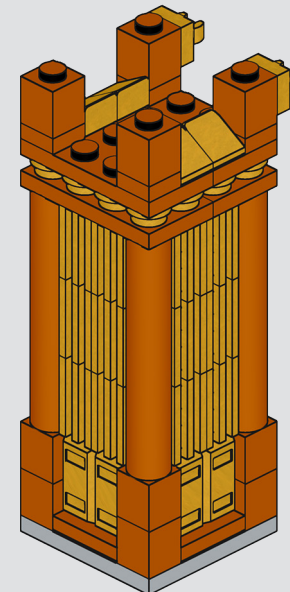

10

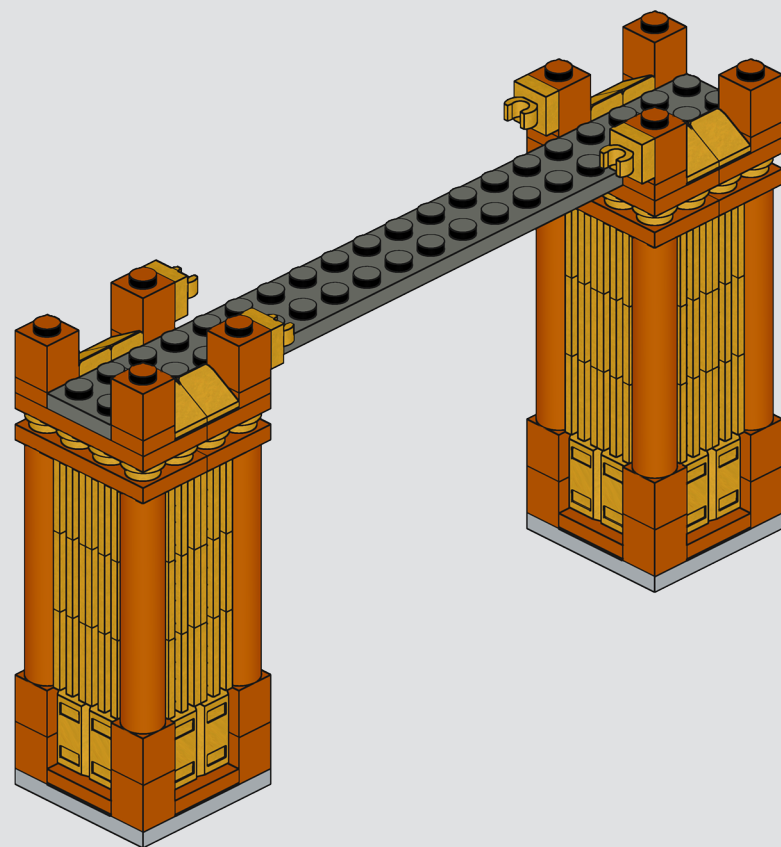
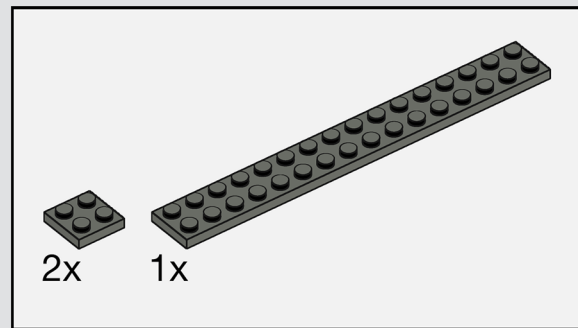

11

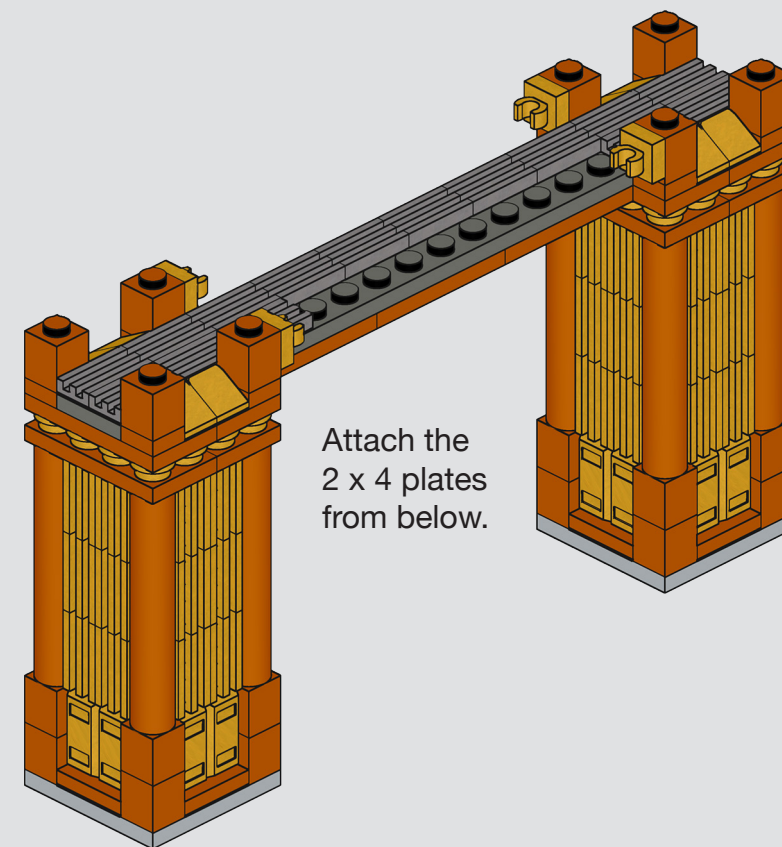
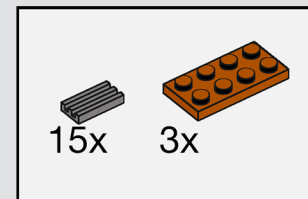

12

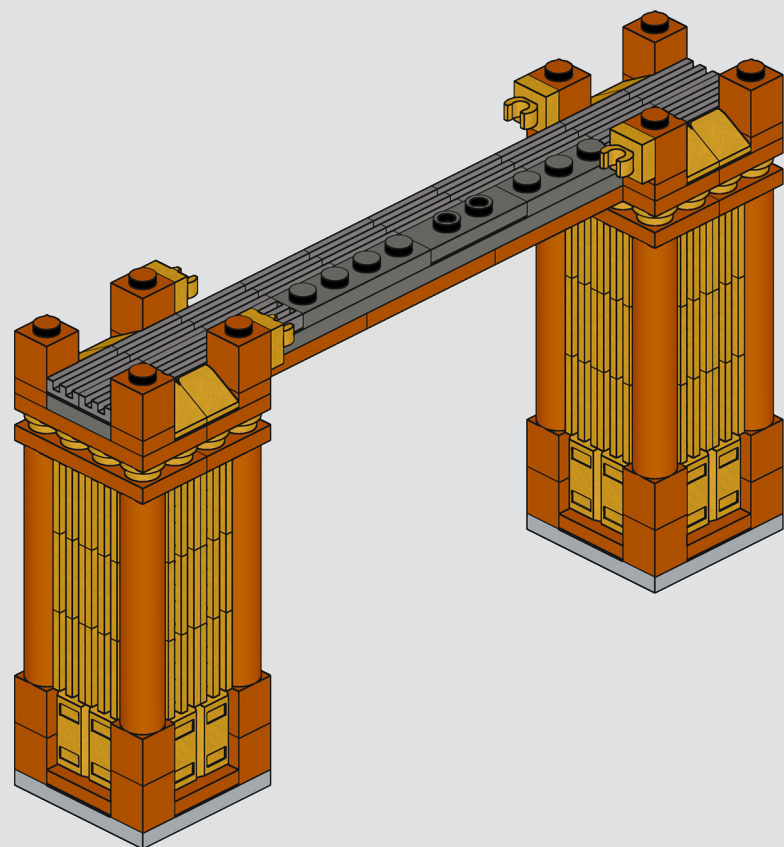
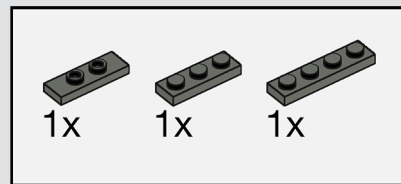

13

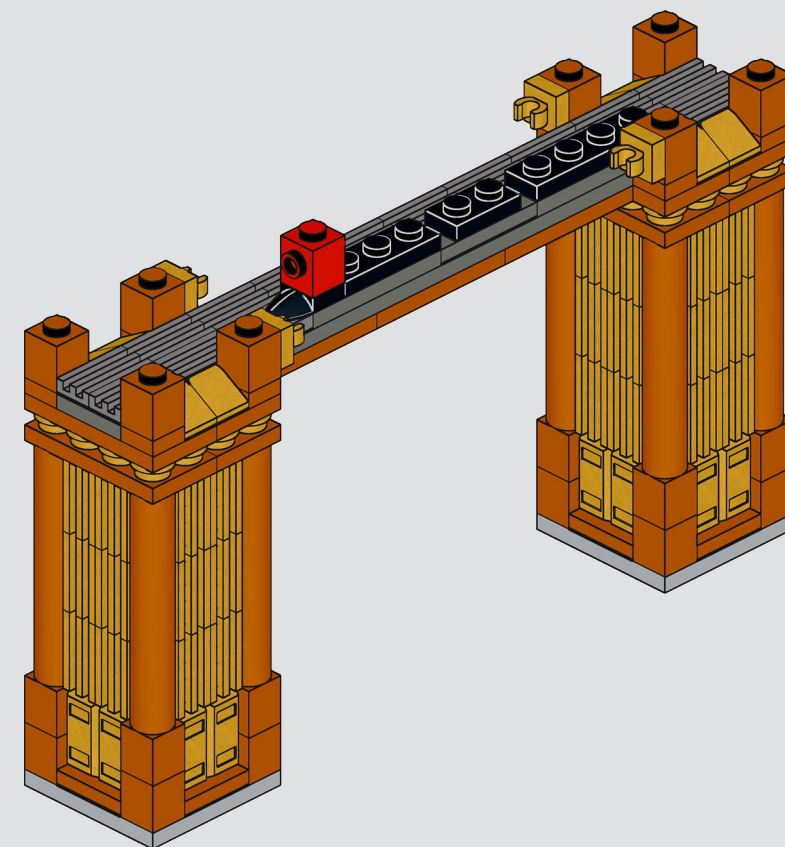
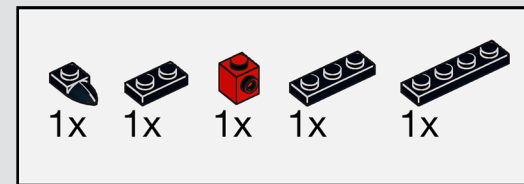

14

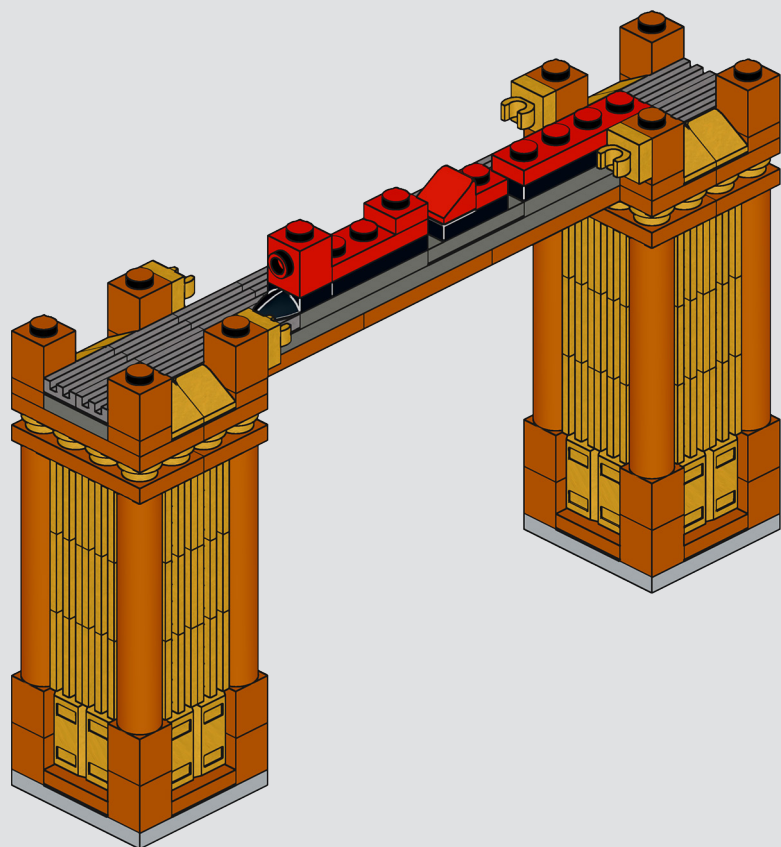
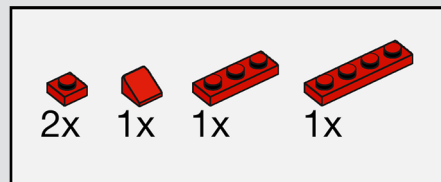

15

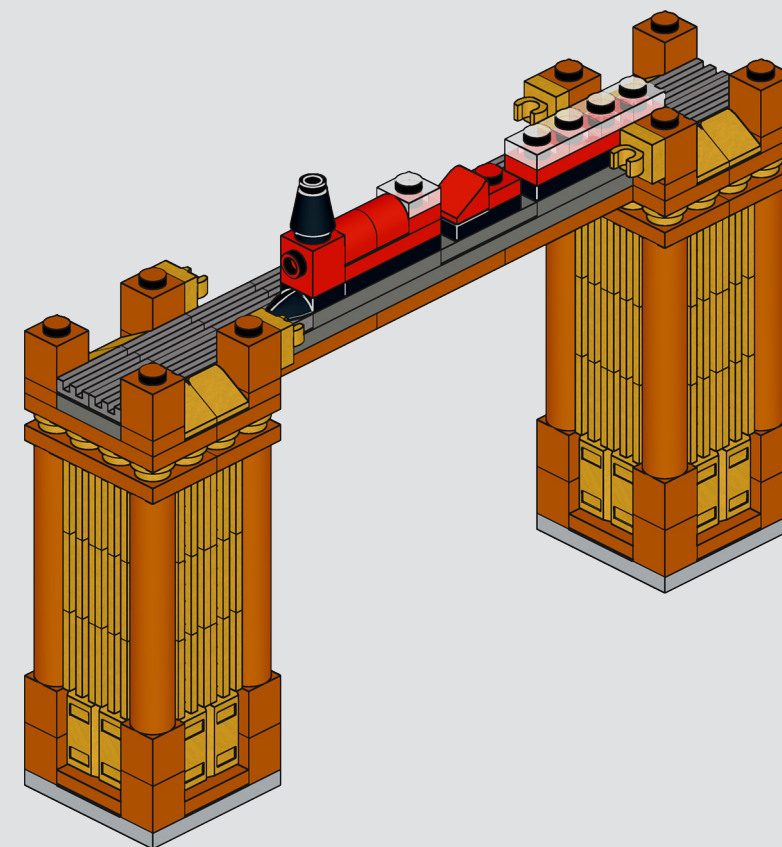
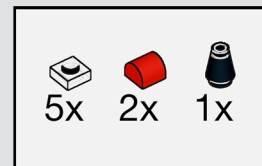

16

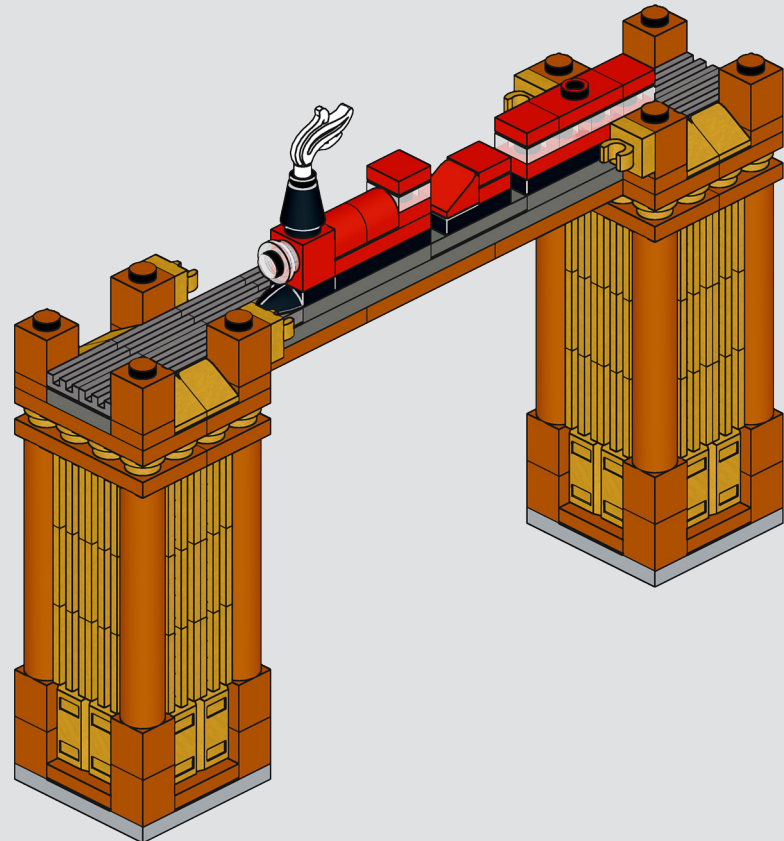
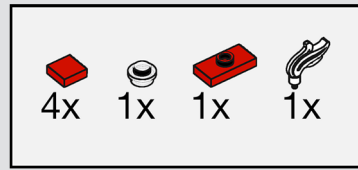

17

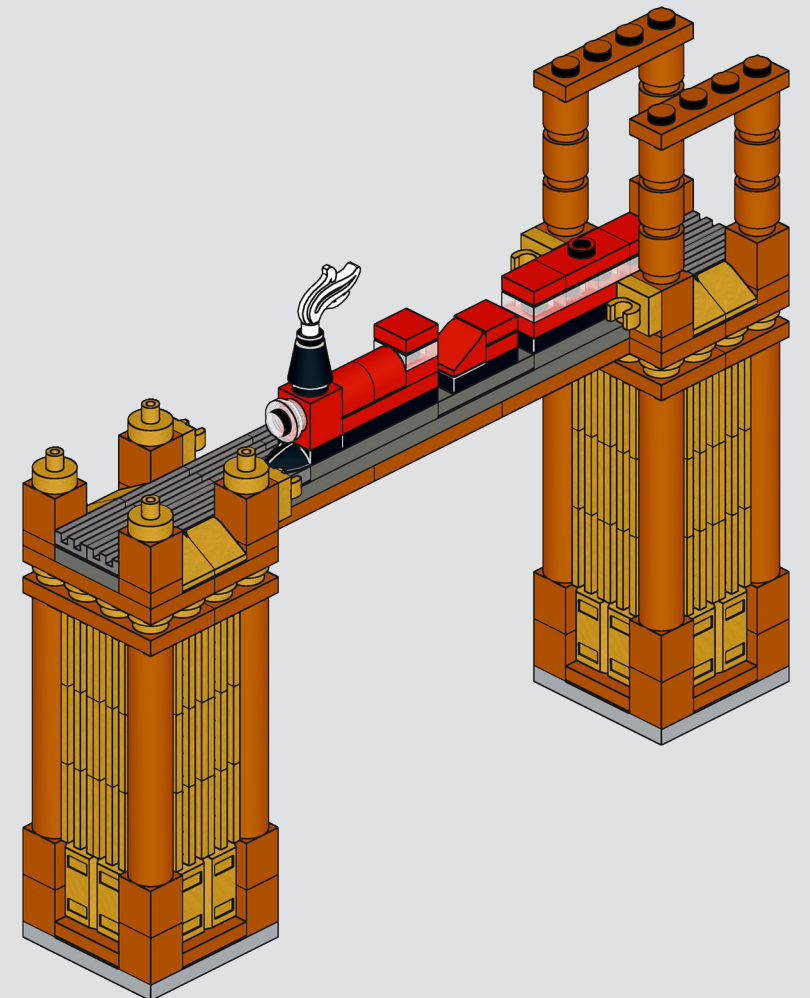
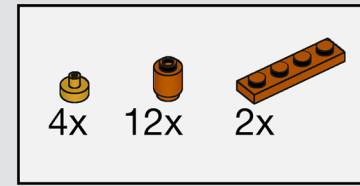

18

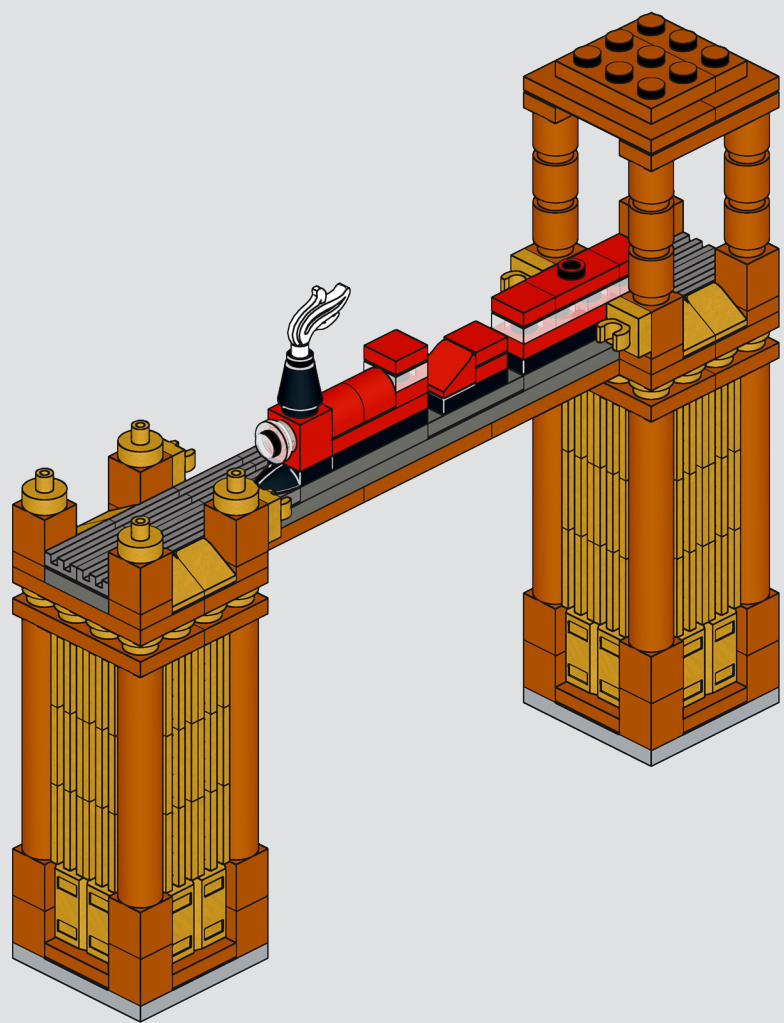
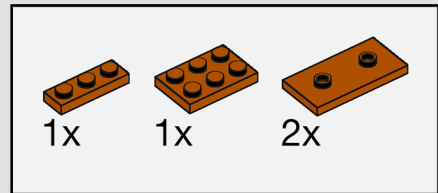

19

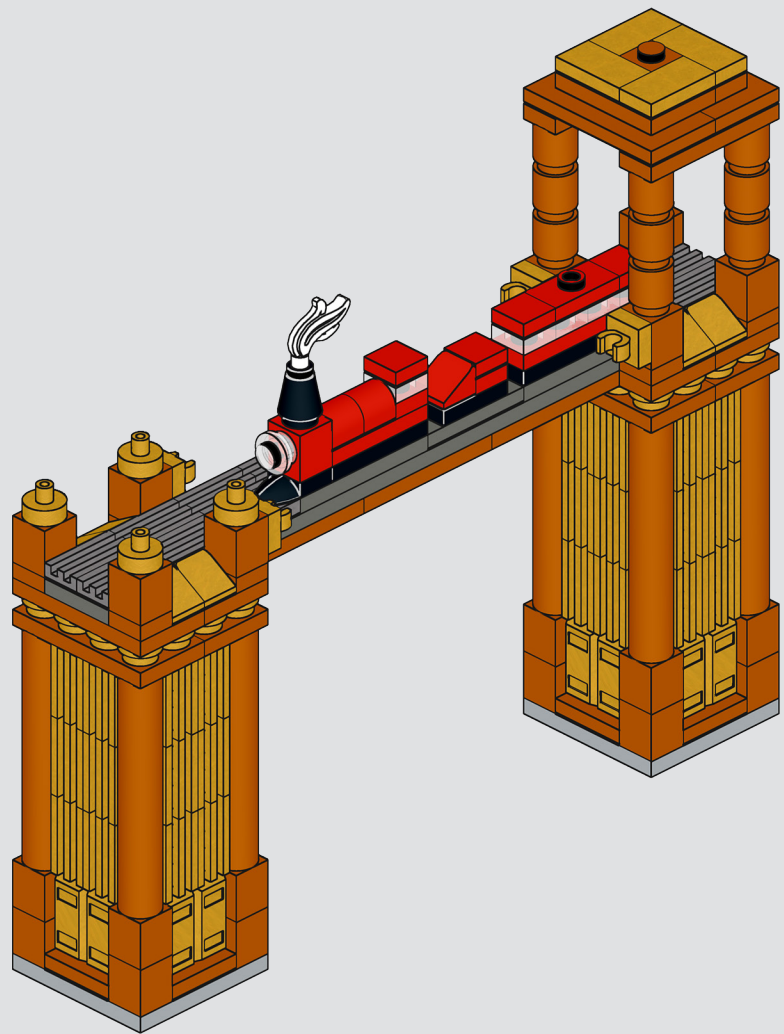
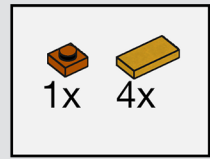

20

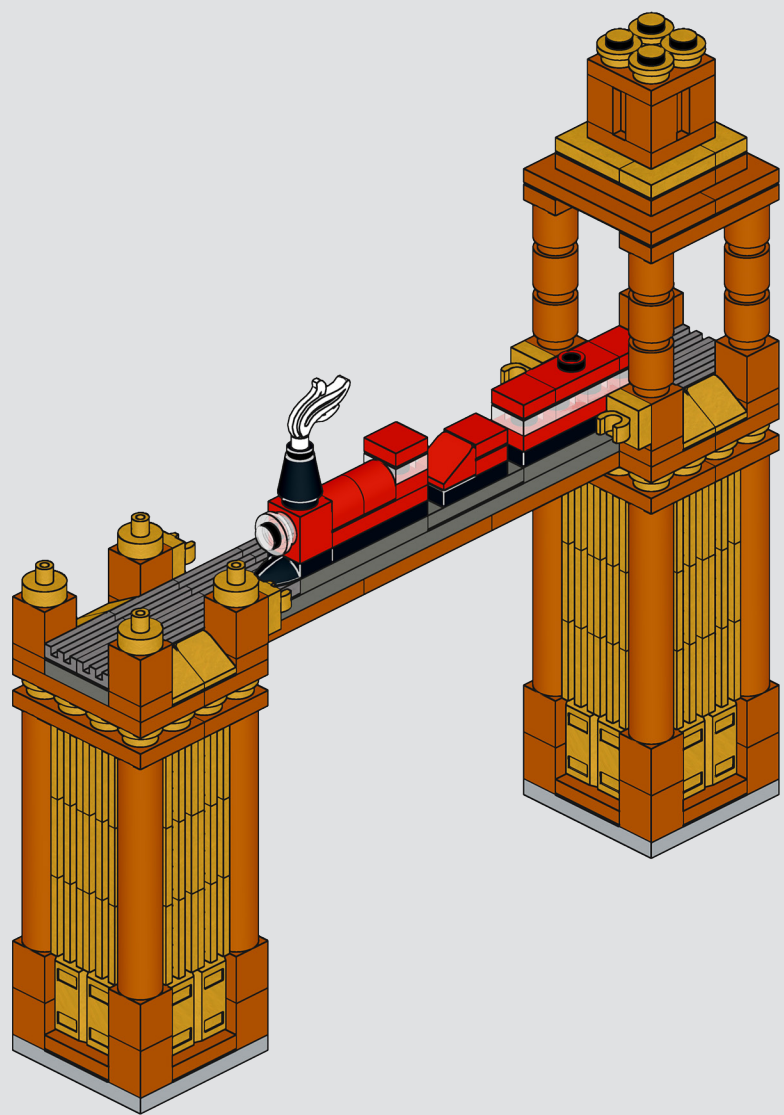
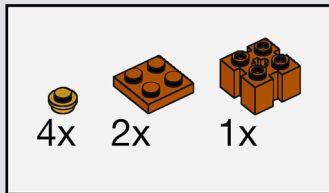

21

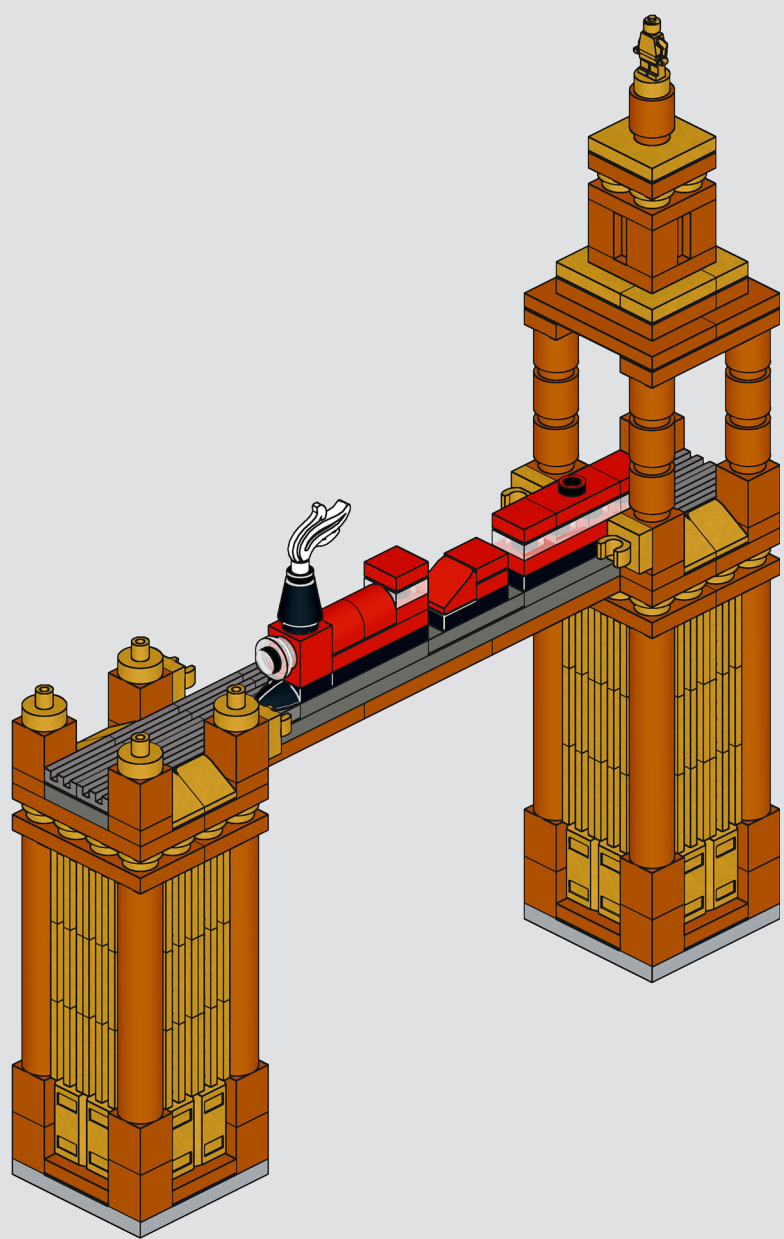
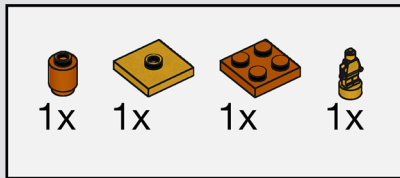



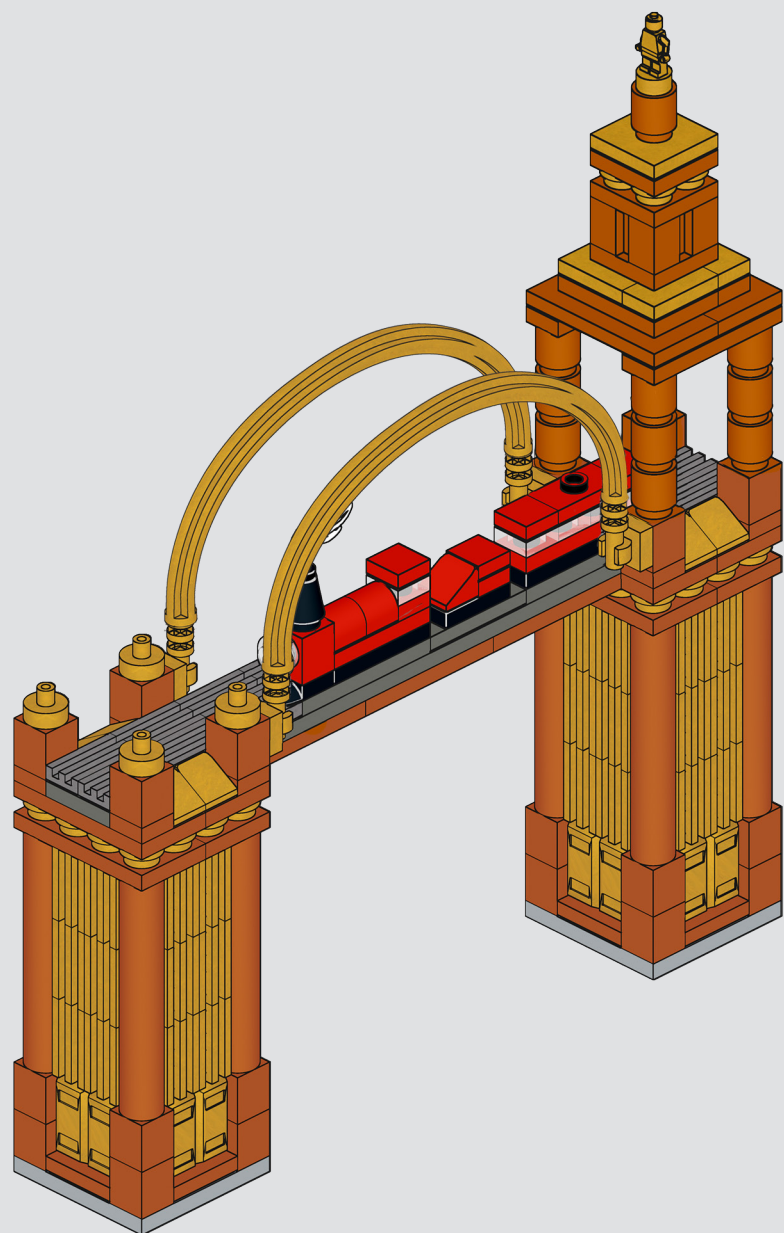
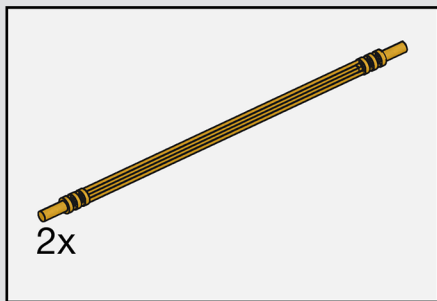



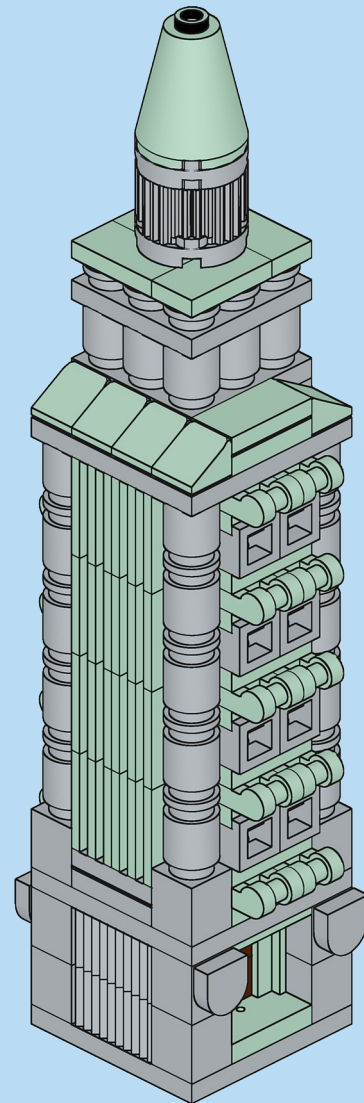















22

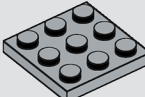
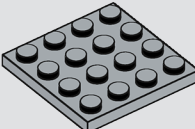
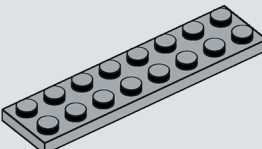

BUILD 5: GOTHIC HEIGHTS



PARTS LIST

 4x 24246	 25x 4073	 1x 3024	 28x 3062	 8x 3005	 16x 4070	 4x 87087
 2x 3023	 2x 3069	 4x 2877	 2x 4032	 2x 3022	 1x 92947	 2x 99207
 2x 44728	 3x 11212	 3x 3031	 2x 3034	 2x 3003		
 5x 54200	 20x 26047	 19x 3023	 16x 2412b	 5x 3069	 2x 90195	 1x 3942c

1

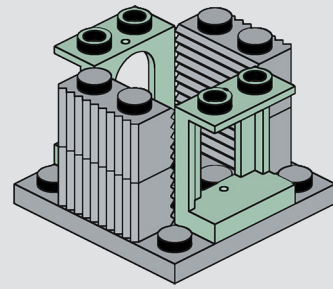
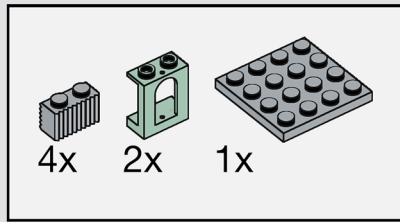

5

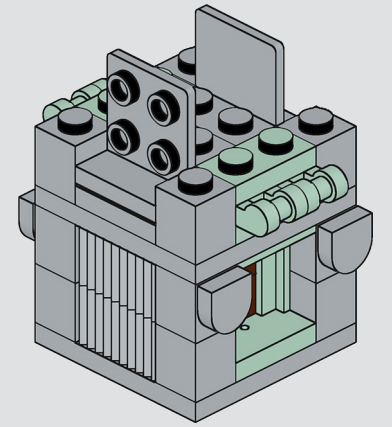
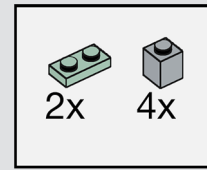

2

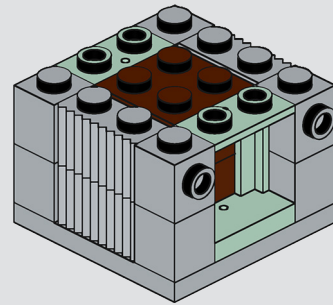
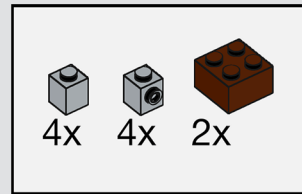

6

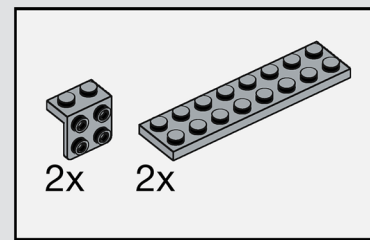

7

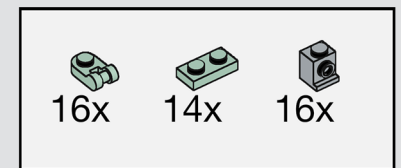

3

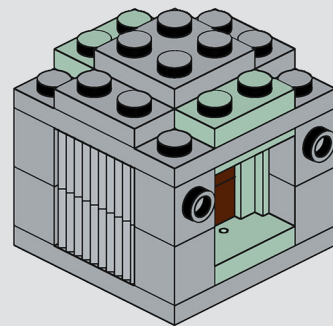
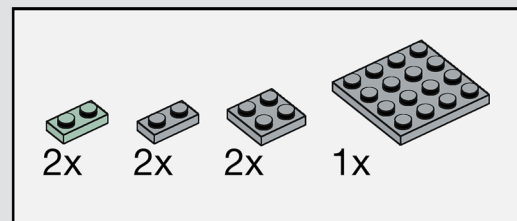

4

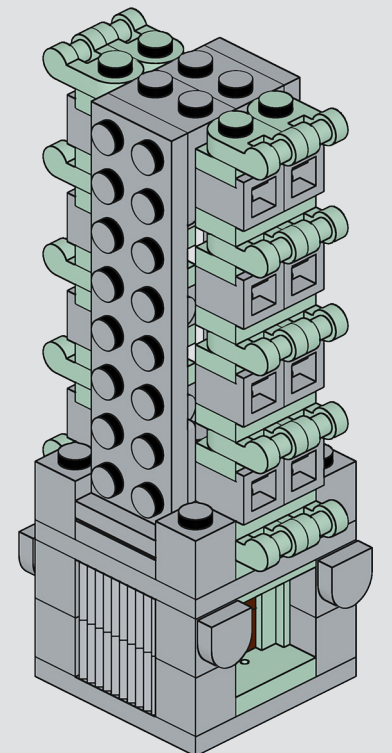
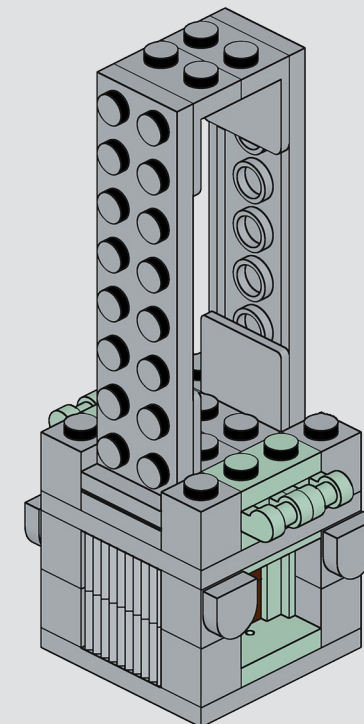
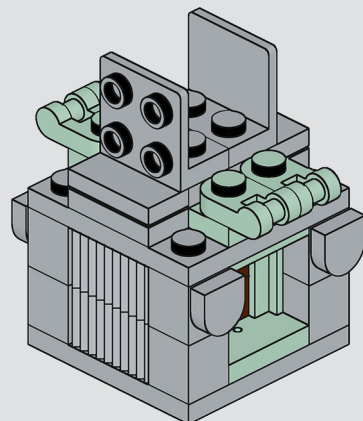
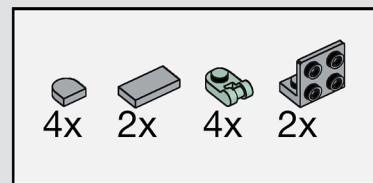

8

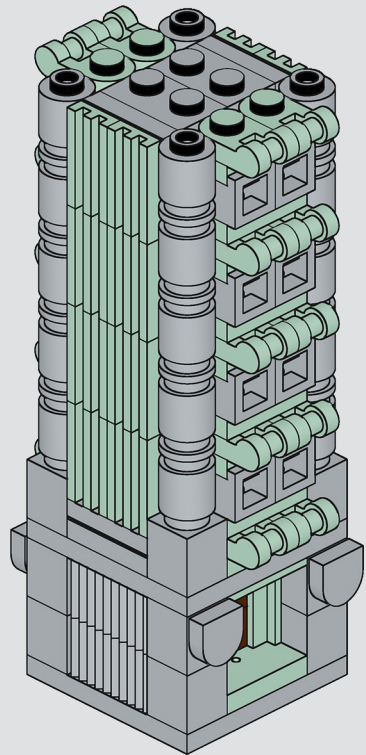
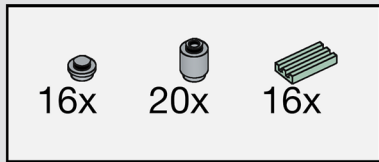

9

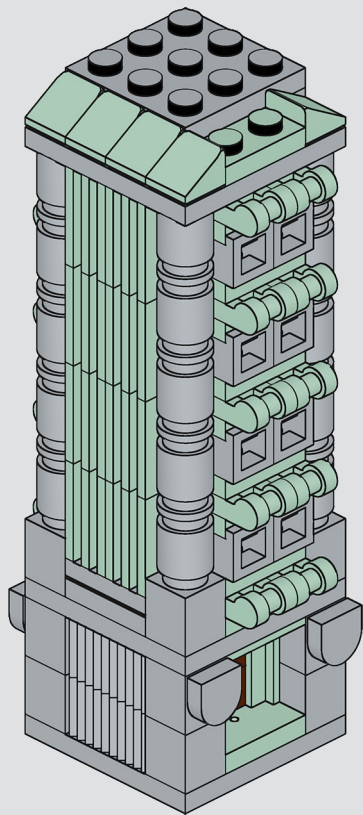
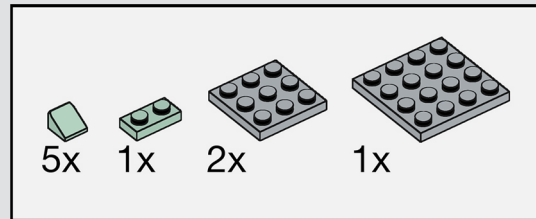

10

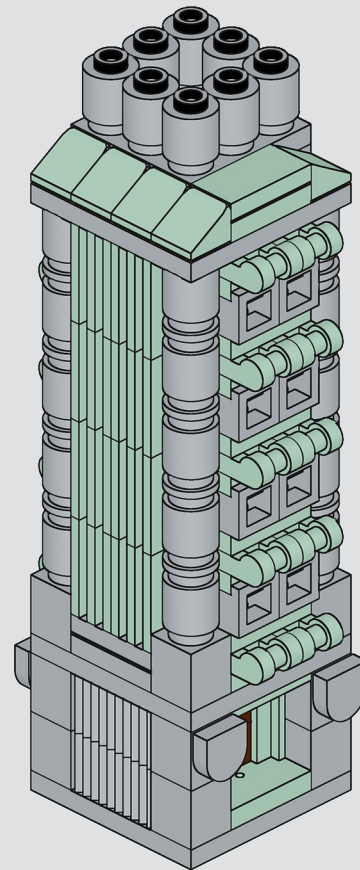
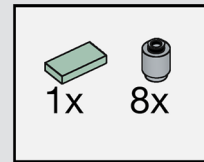

11

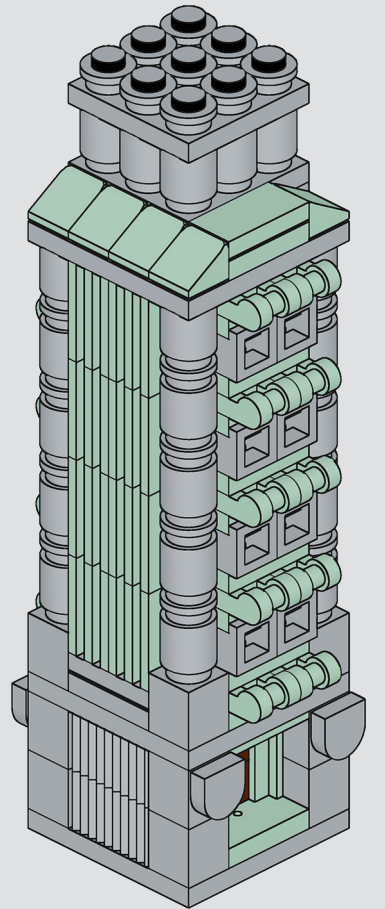
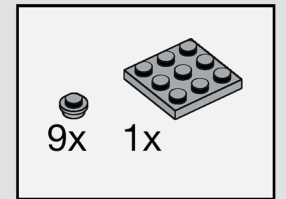

12

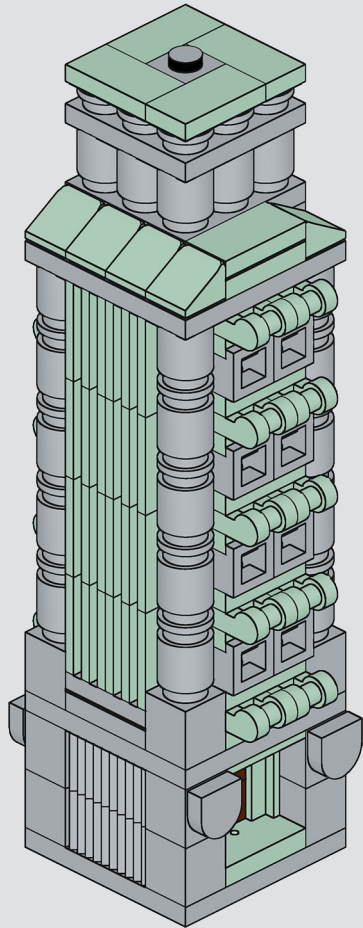
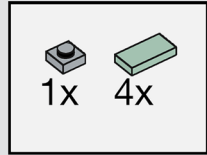



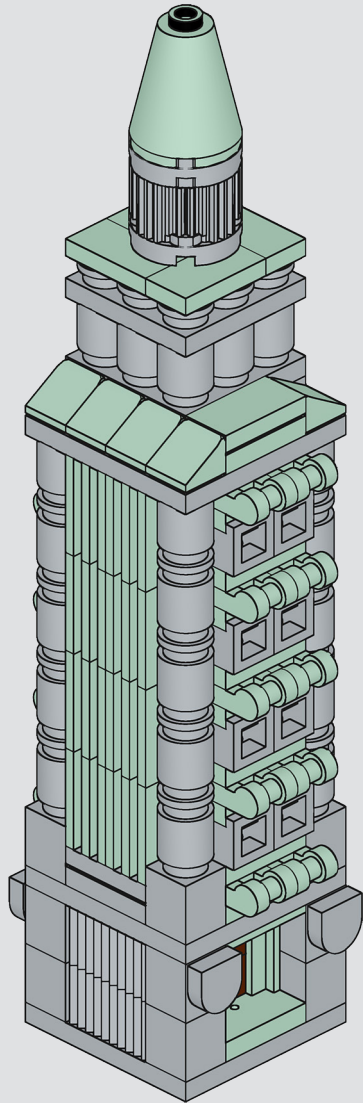
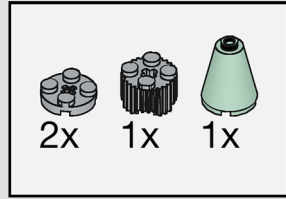





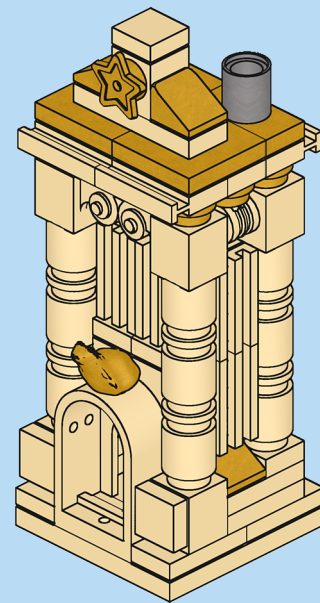



















13



BUILD 6: GOLDEN TOAD BANK

PARTS LIST



 3x 3070	 8x 4073	 2x 3024	 12x 3062	 3x 87087	 2x 26604	 9x 3023	 1x 3069
 6x 15573	 8x 2412b	 4x 32028	 6x 20310	 1x 3003	 1x 99207	 1x 3623	 1x 22885
 1x 90195	 1x 30044	 2x 3710	 1x 3031	 1x 18654	 10x 4073		
 4x 54200	 1x 11609	 1x x223	 2x 15573	 2x 99563	 2x 87580		

1

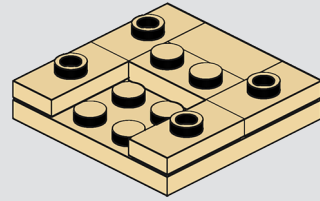
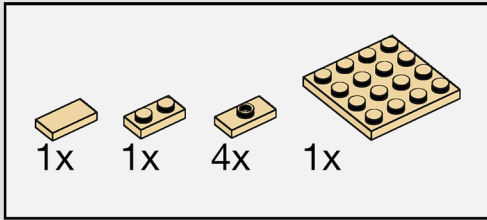

5

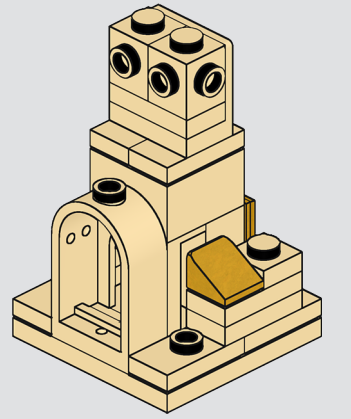
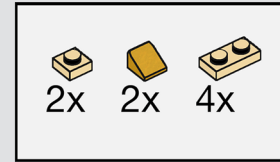

2

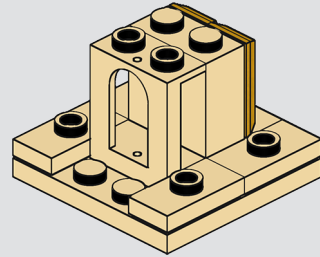
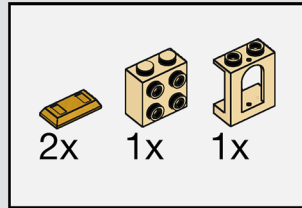

6

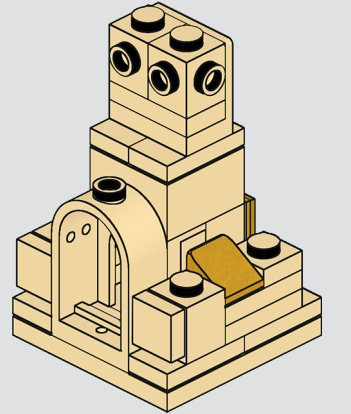
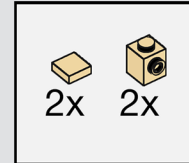

3

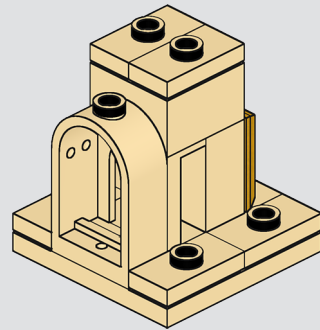
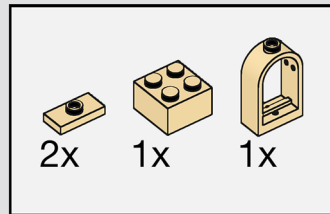

4

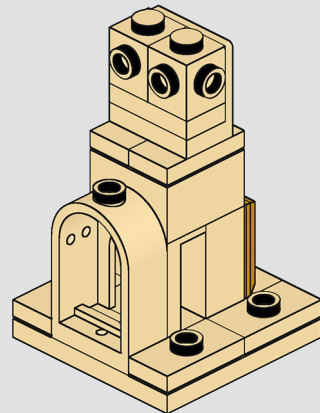
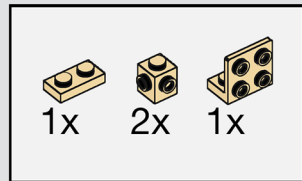

7

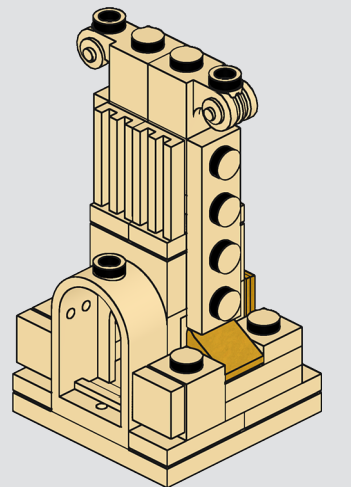
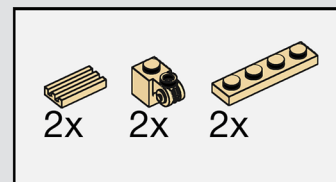

8

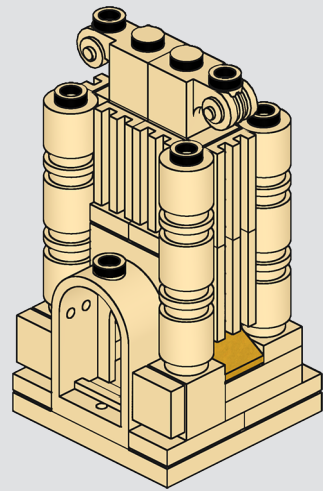
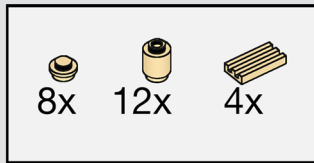

11

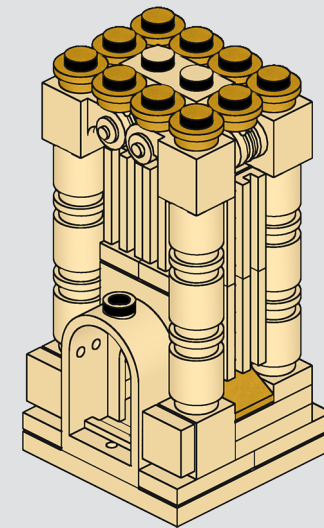
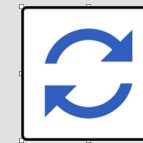
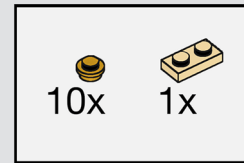

9

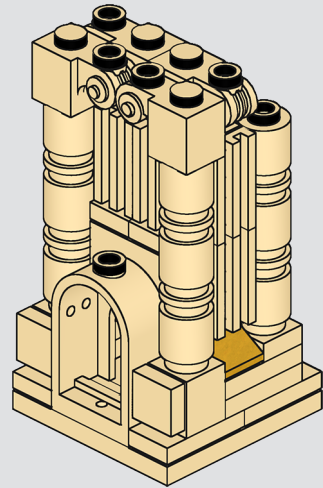
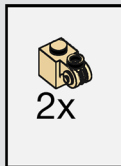

12

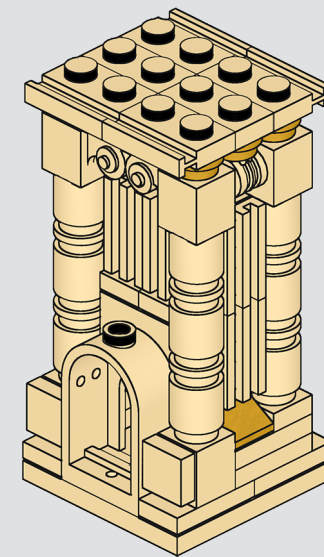
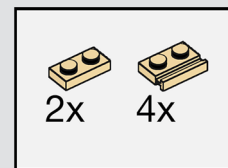

10

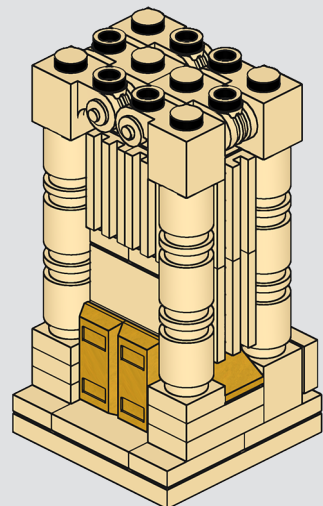
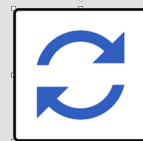
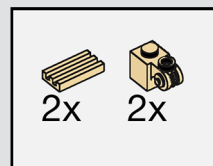

13

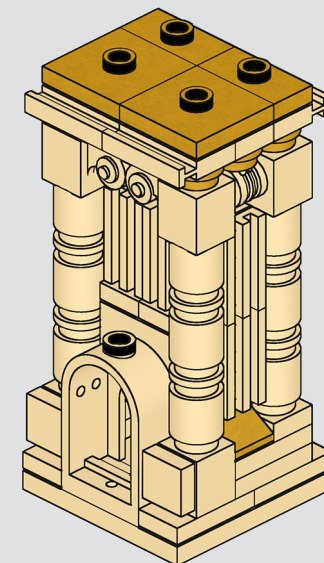
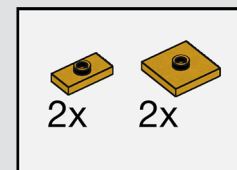

14

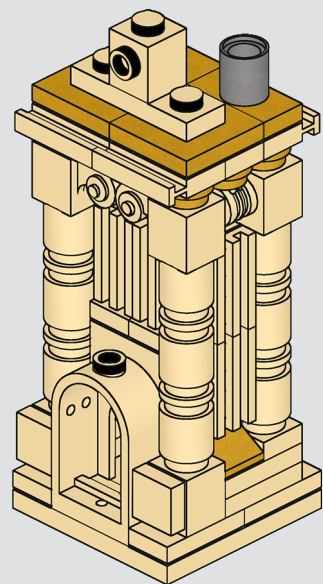
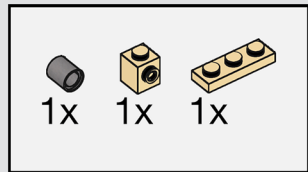



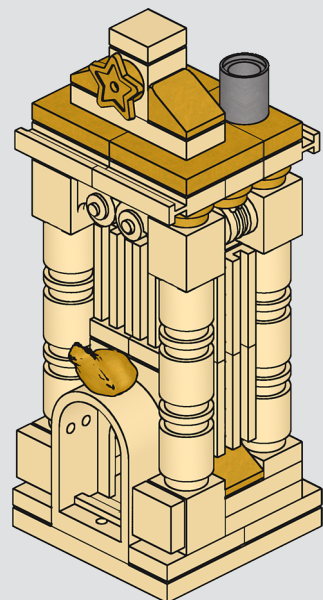
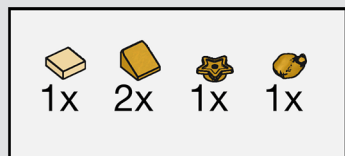



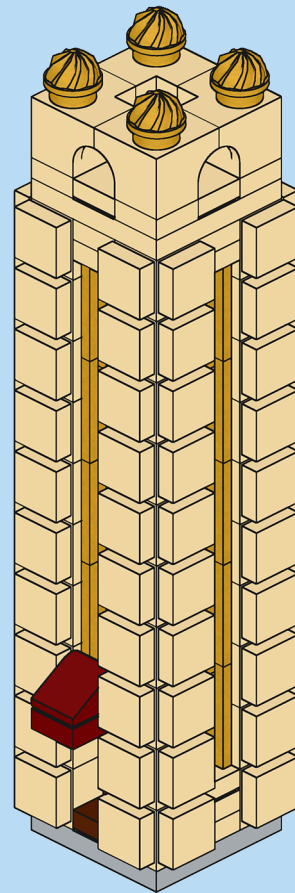



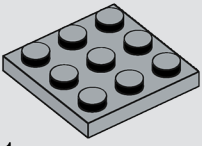
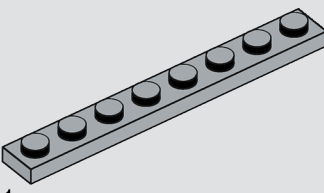
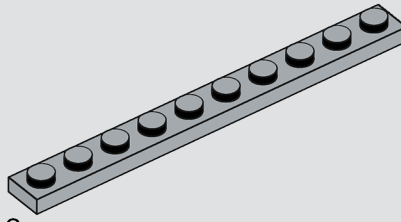

15

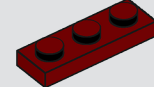

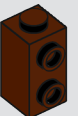
BUILD 7: CORNERSTONE COMMONS

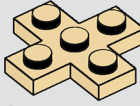
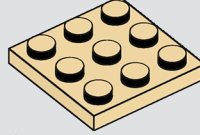

PARTS LIST

- | | | | | | | |
|--|--|--|---|---|--|---|
| 
1x
3005, 86 | 
1x
11212, 86 | 
1x
3460, 86 | 
3x
4477, 86 | | | |
| 
4x
4733, 1 | 
1x
3070, 59 | 
1x
54200, 59 | 
1x
3623, 59 | 
1x
3024, 88 | 
1x
99563, 88 | 
1x
32952, 88 |
| 
89x
3070, 2 | 
16x
3024, 2 | 
40x
26604, 2 | 
4x
38585, 2 | 
2x
15397, 2 | 
1x
11212, 2 | 
4x
15470, 115 |
| 
19x
2412b, 115 | | | | | | |

1

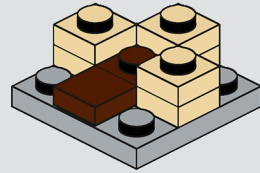
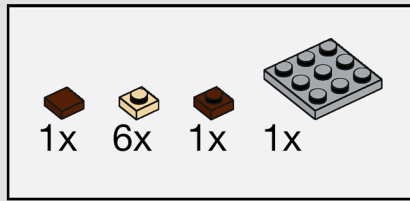

5

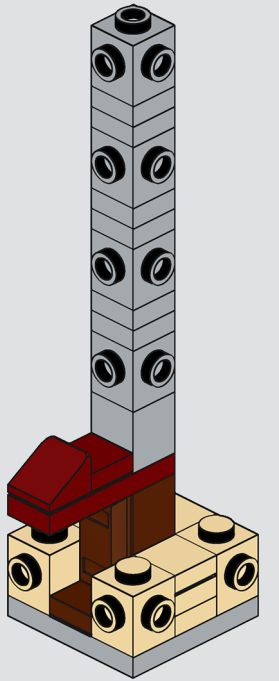
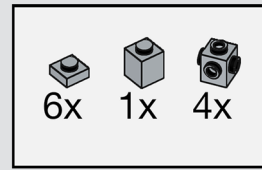

2

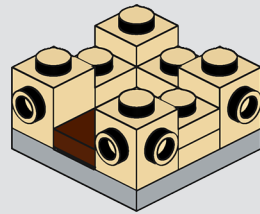

6

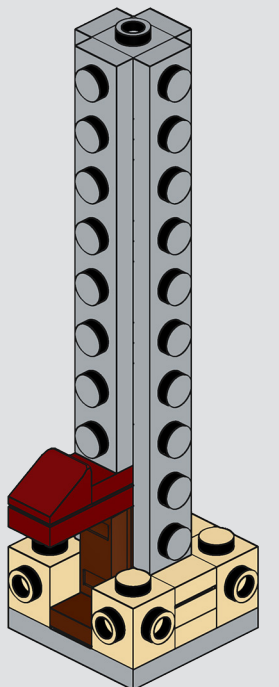
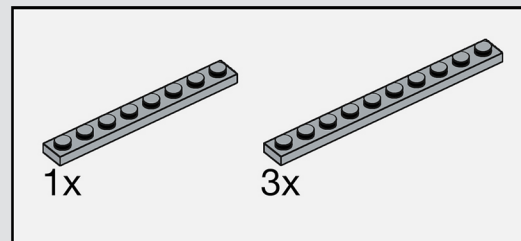

3

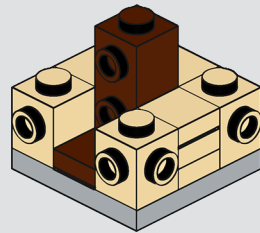
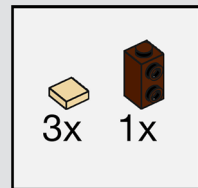

4

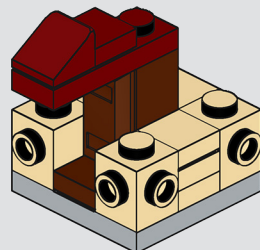
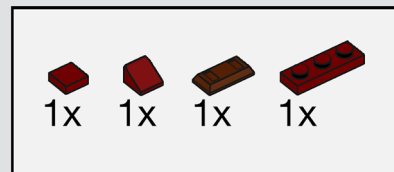

7

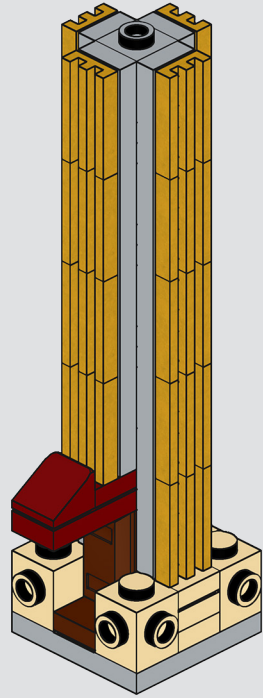
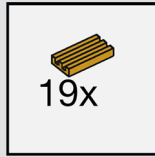

9

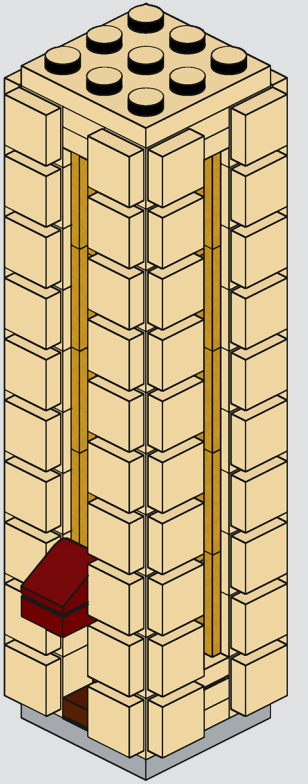
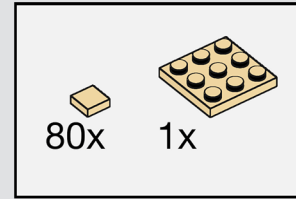

8

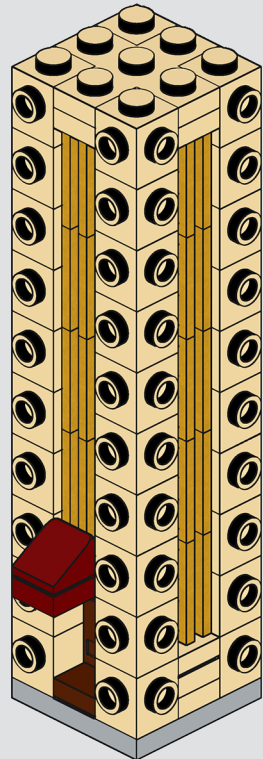
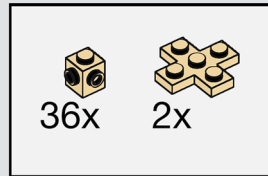

10

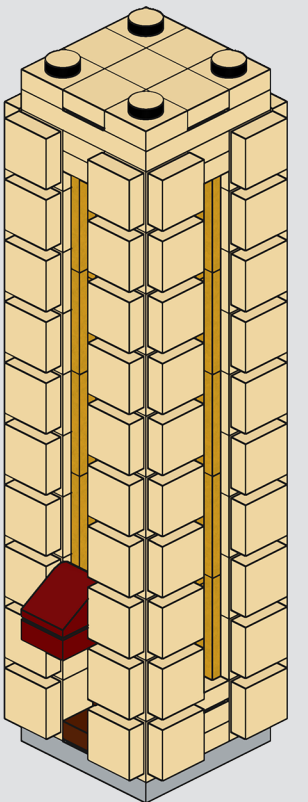
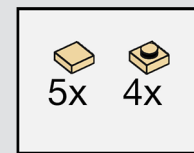



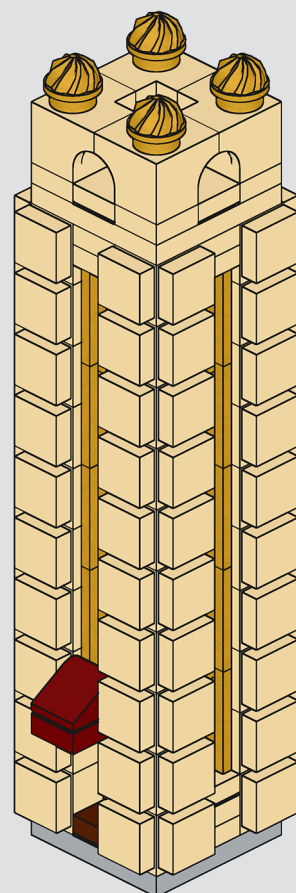
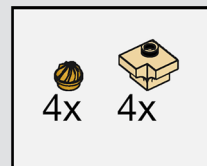



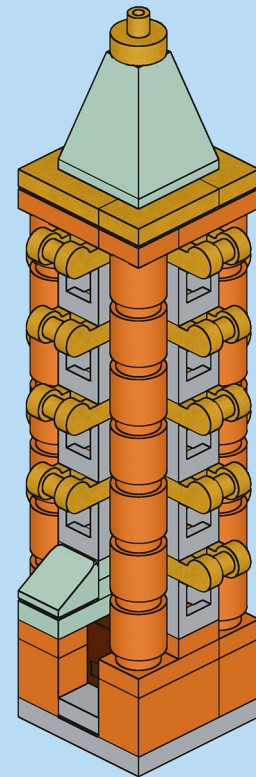





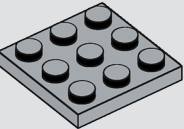

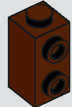
11

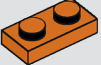
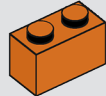
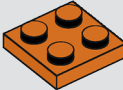

BUILD 8: BRICKWELL MANOR

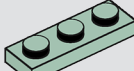
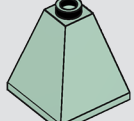

PARTS LIST

 1x 3070	 19x 4070	 1x 11212	 1x 3024	 1x 99563	 1x 32952	 6x 3024
 28x 3062	 1x 3005	 5x 3023	 3x 3004	 1x 3022	 1x 54200	 2x 3023
 1x 3623	 1x 3688	 1x 20482	 19x 26047	 4x 3069		

1

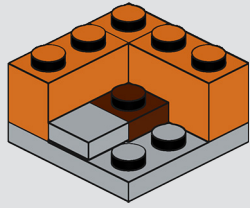
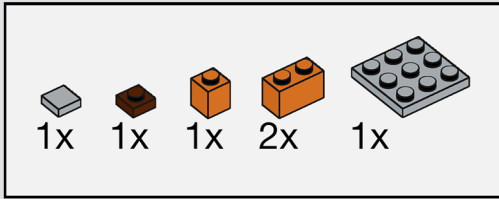

2

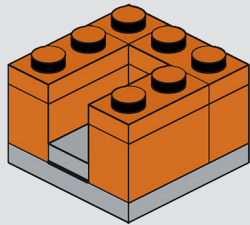
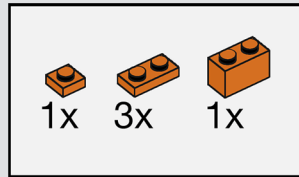

3

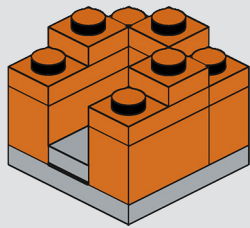

4

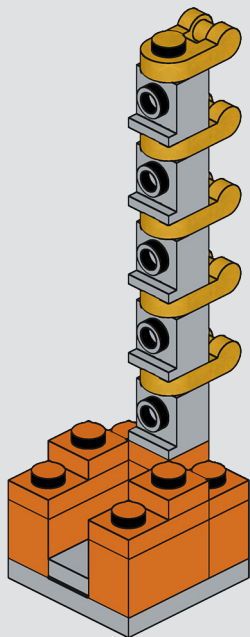
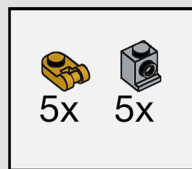

5

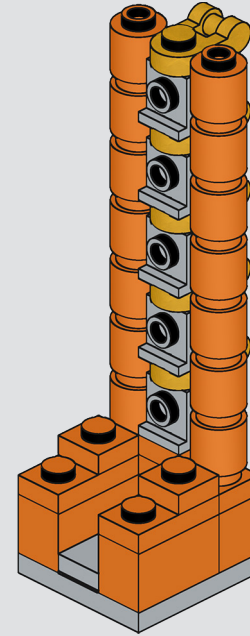
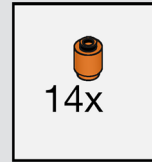

6

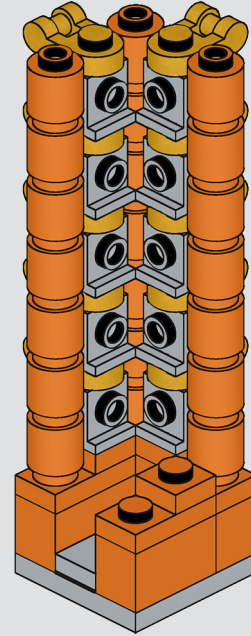
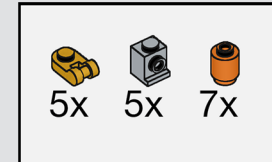

7

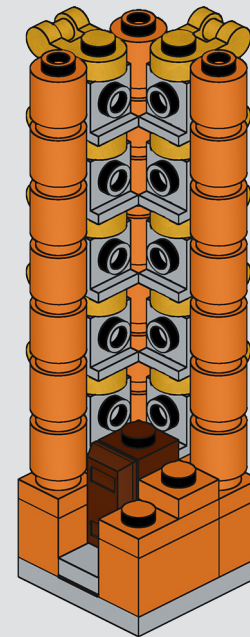
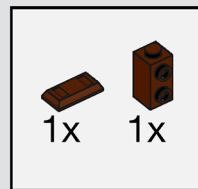

8

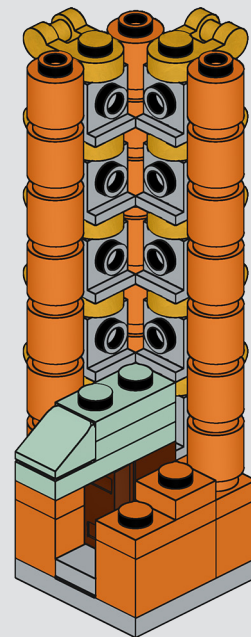
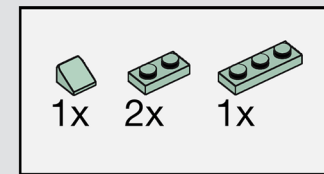

9

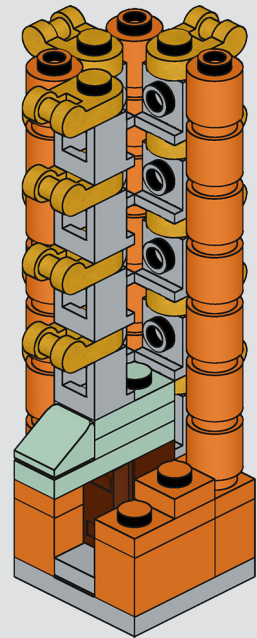
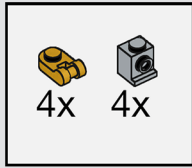

10

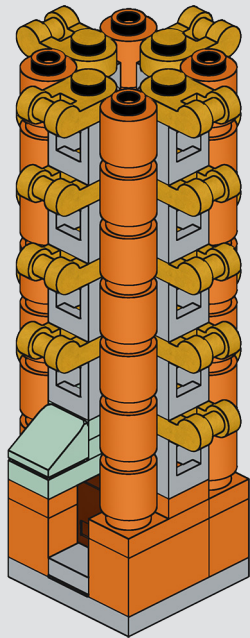
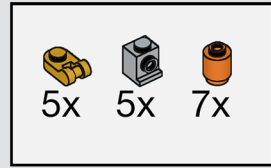

13

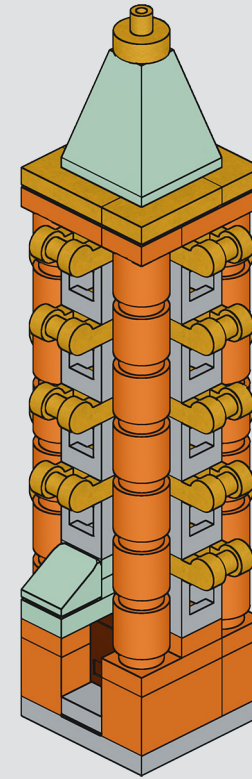
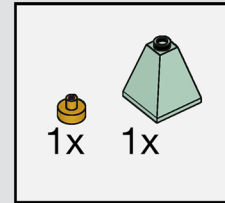

11

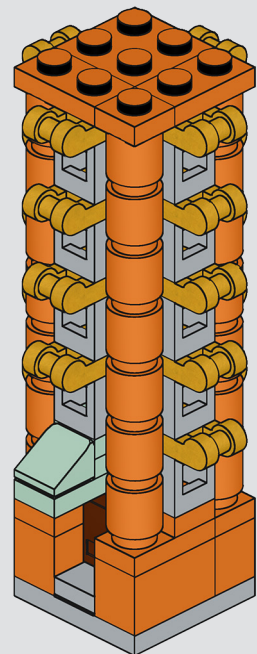
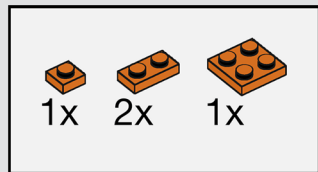



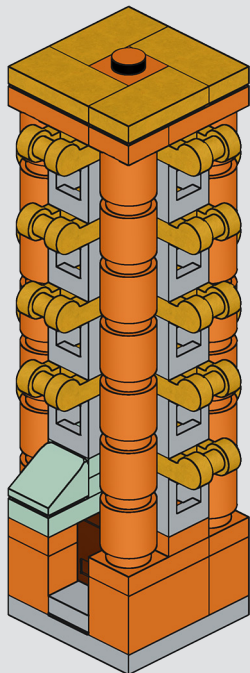
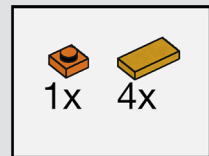



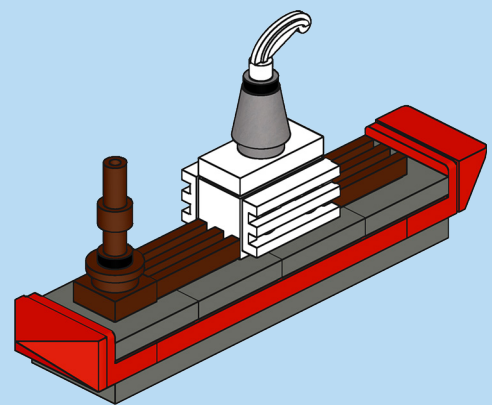



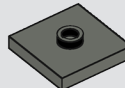
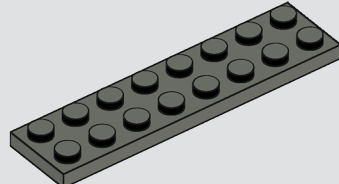

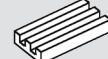
12

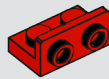
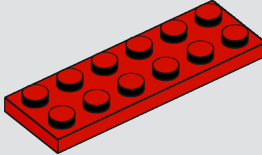

BUILD 9: RIVER BARGE



PARTS LIST

- | | | | | | |
|--|--|--|--|--|--|
| 
4x
87580 | 
1x
3034 | 
1x
4502a | 
2x
2412b | 
1x
15573 | 
1x
52107 |
| 
1x
85984 | 
1x
15571 | 
2x
99780 | 
1x
3795 | 
1x
3024 | 
1x
85861 |
| 
1x
78258 | 
2x
2412b | 
1x
4589b | | | |

1

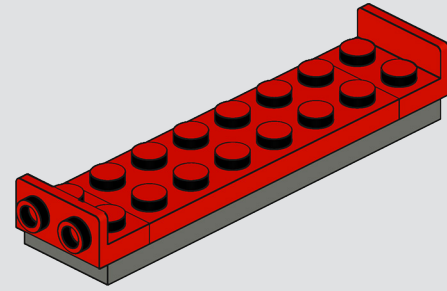
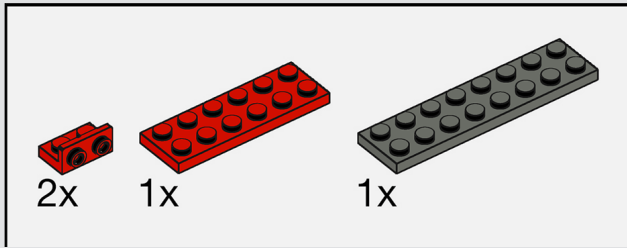

4

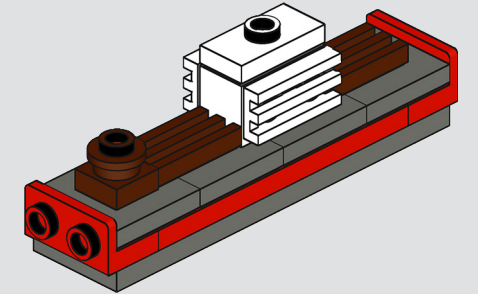
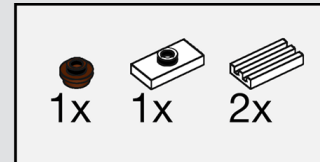

2

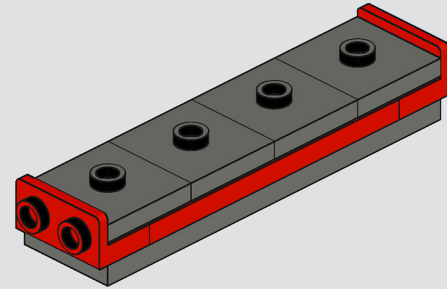
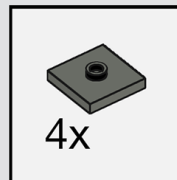

5

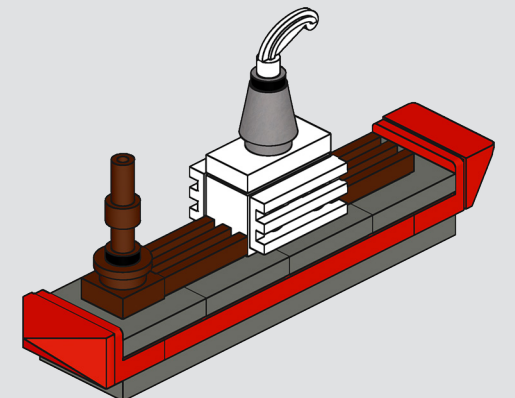
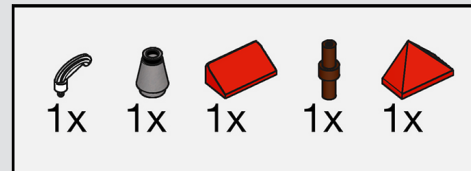



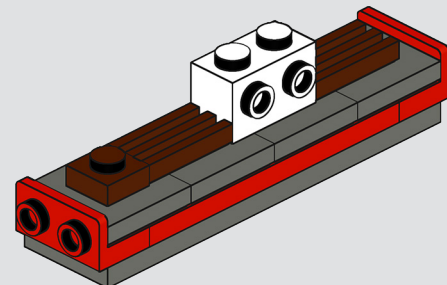
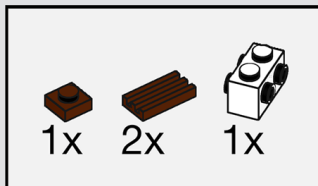























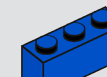
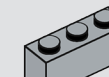
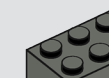
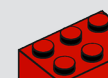

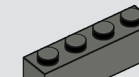

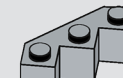
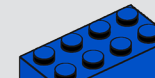













3



BUILD 10: THE BASE



PARTS LIST

- | | | | | | | | |
|--|--|--|--|--|--|---|---|
| 
8x
58176 | 
23x
3005 | 
1x
3005 | 
4x
3005 | 
3x
3005 | 
2x
87087 | 
1x
4733 | 
3x
3065 |
| 
5x
3004 | 
9x
2877 | 
7x
3004 | 
2x
3004 | 
2x
3004 | 
4x
11211 | 
2x
3003 | 
11x
87620 |
| 
13x
3622 | 
3x
3622 | 
5x
3002 | 
3x
3002 | 
1x
3010 | 
2x
3010 | 
4x
3659 | |
| 
1x
2462 | 
6x
3001 | 
4x
3001 | 
1x
3009 | 
4x
3009 | | | |
| 
10x
2456 | 
2x
2456 | 
3x
3007 | 
7x
4589b | 
2x
99563 | | | |
| 
1x
90398 | 
7x
64644 | 
8x
24866 | 
7x
3024 | 
8x
4073 | 
4x
3024 | 
1x
3024 | |
| 
2x
3024 | 
5x
3024 | 
4x
15573 | 
2x
3023 | 
10x
3023 | 
11x
3023 | 
2x
3023 | 
6x
3023 |

4x 15573
11x 3023
2x 3023
1x 87580
1x 87580
1x 3022
7x 3022

5x 3022
17x 3022
1x 87580
3x 3022
1x 3623
11x 3021
12x 3021

4x 3021
2x 3021
1x 3021
4x 3710
8x 3710
1x 3710

2x 3710
4x 11212
46x 3020
1x 3020
4x 3020
9x 3020

13x 3020
1x 3666
4x 3795
3x 3795
1x 3795

1x 3460
6x 3034
5x 3034
1x 3034

4x 3035
1x 3832
4x 3030

2x 3030
1x 2445

7x 4282
4x 3027

7x 30153
4x 43888
5x 3070
4x 24246
7x 3070
18x 3070
1x 25269
2x 3069
23x 3069
17x 3069
2x 2412b
3x 3069
1x 35787
5x 2431

29x 2431
1x 2431
6x 6636
3x 4162
27x 60598

1

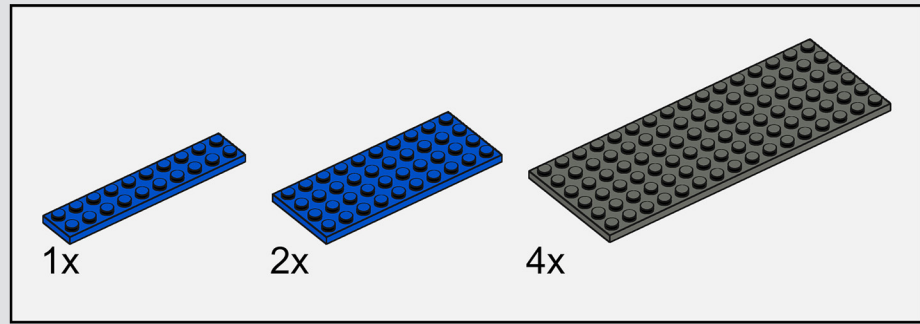

2

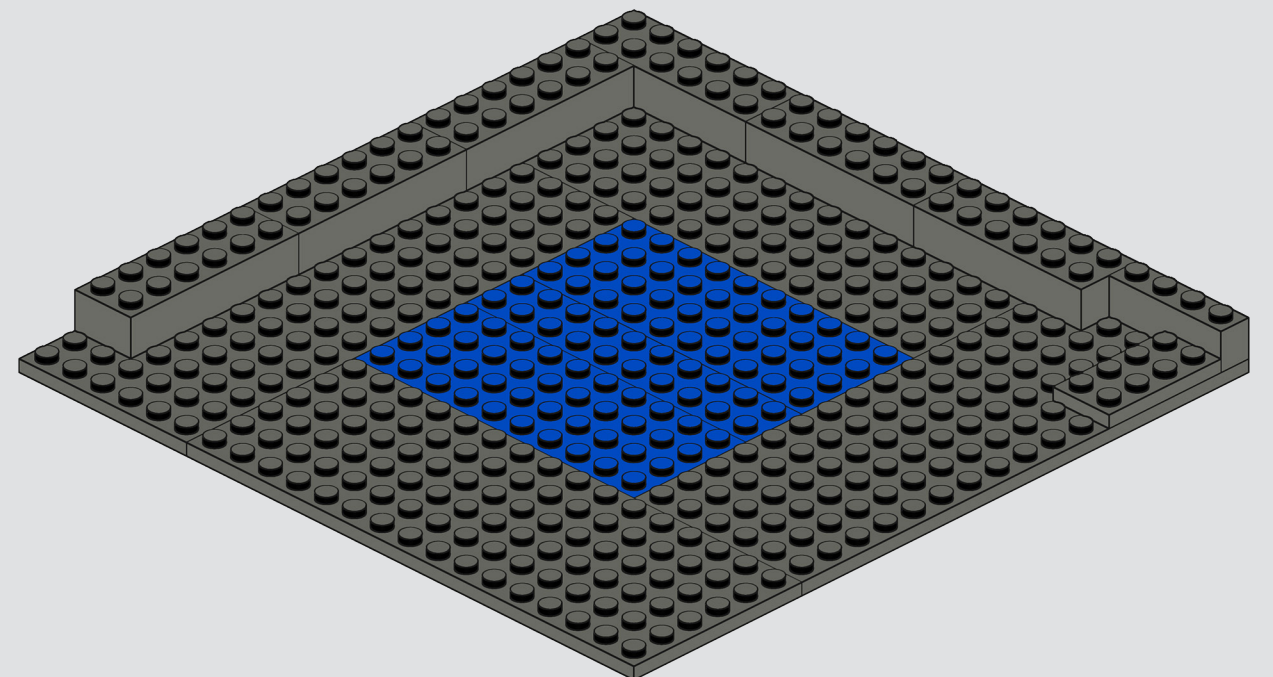
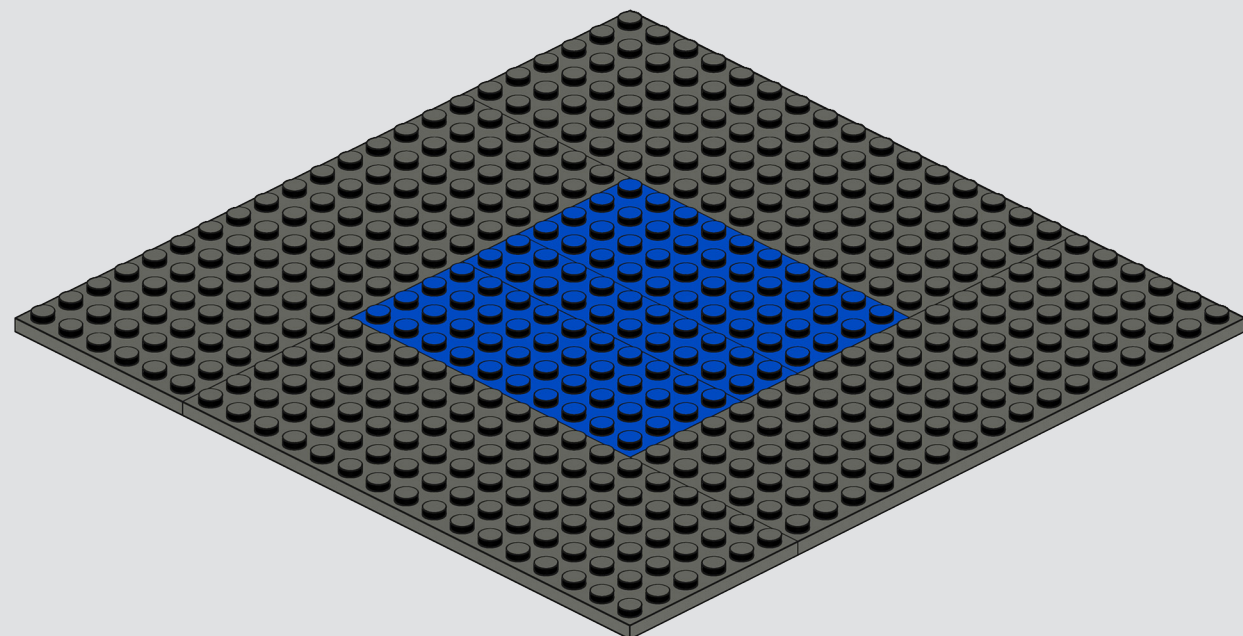
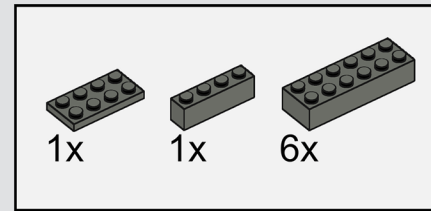

3

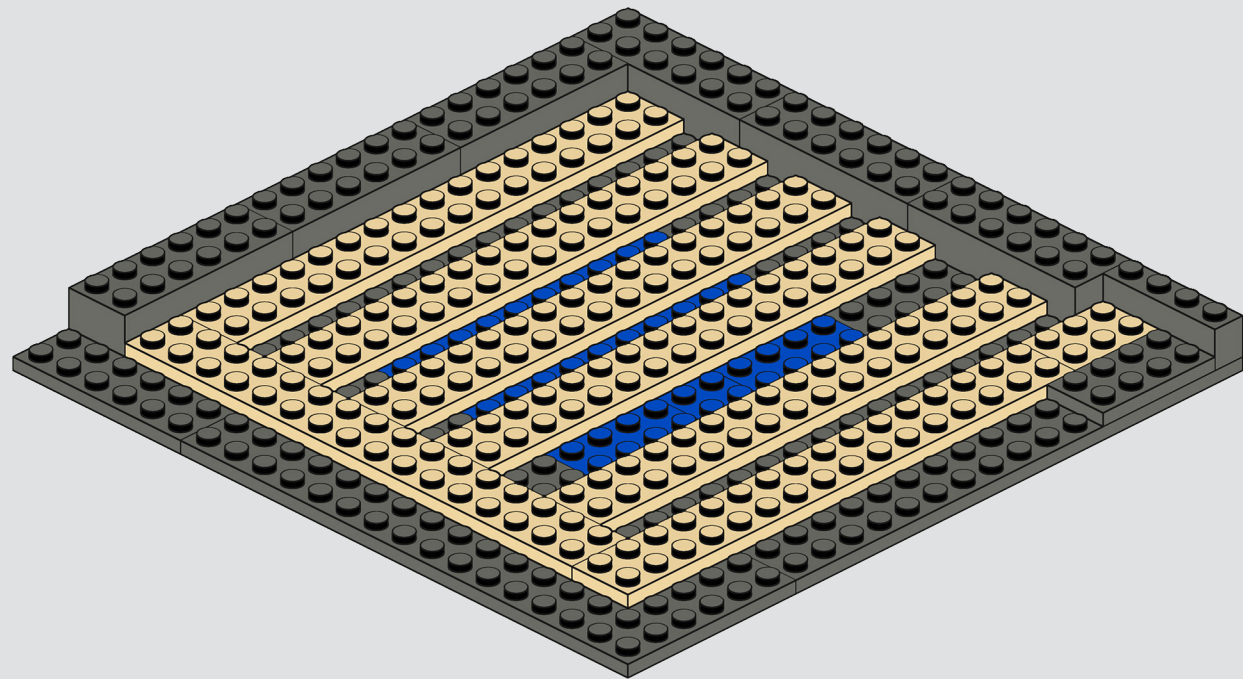
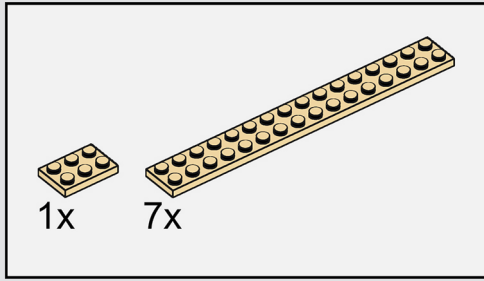

4

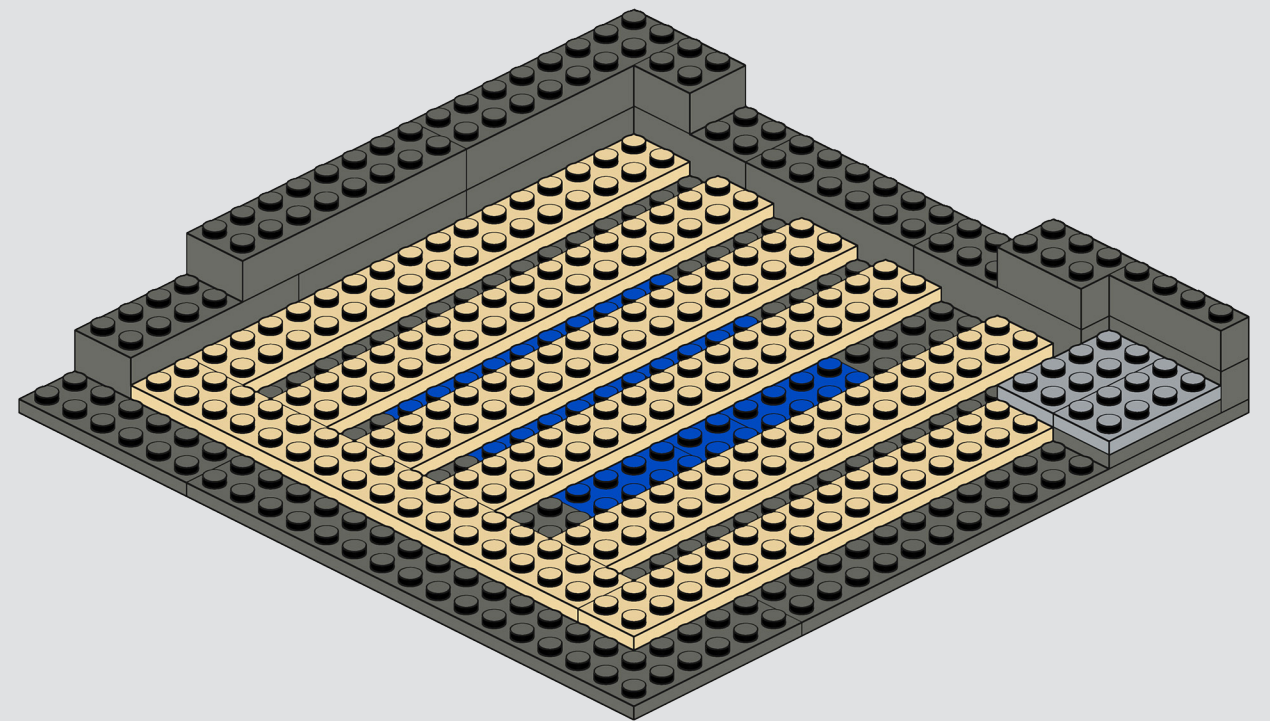
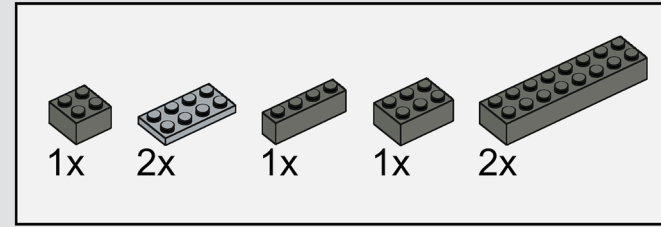

5

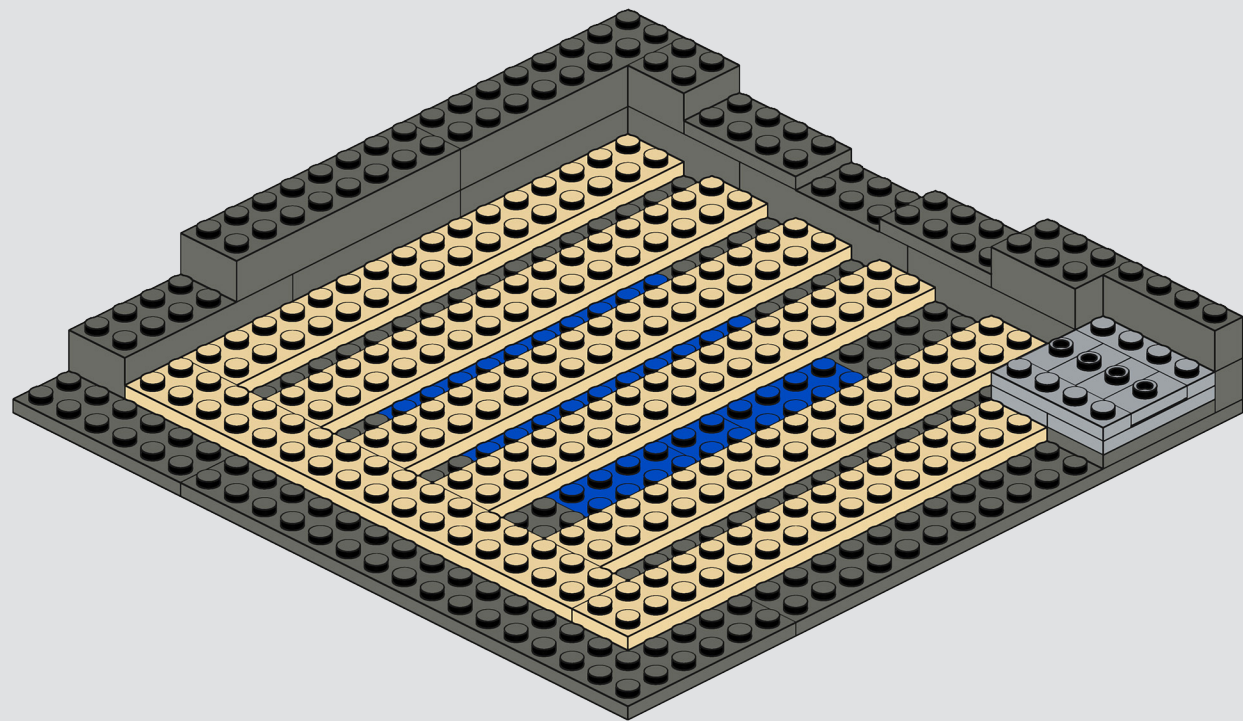
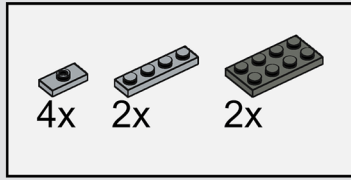

6

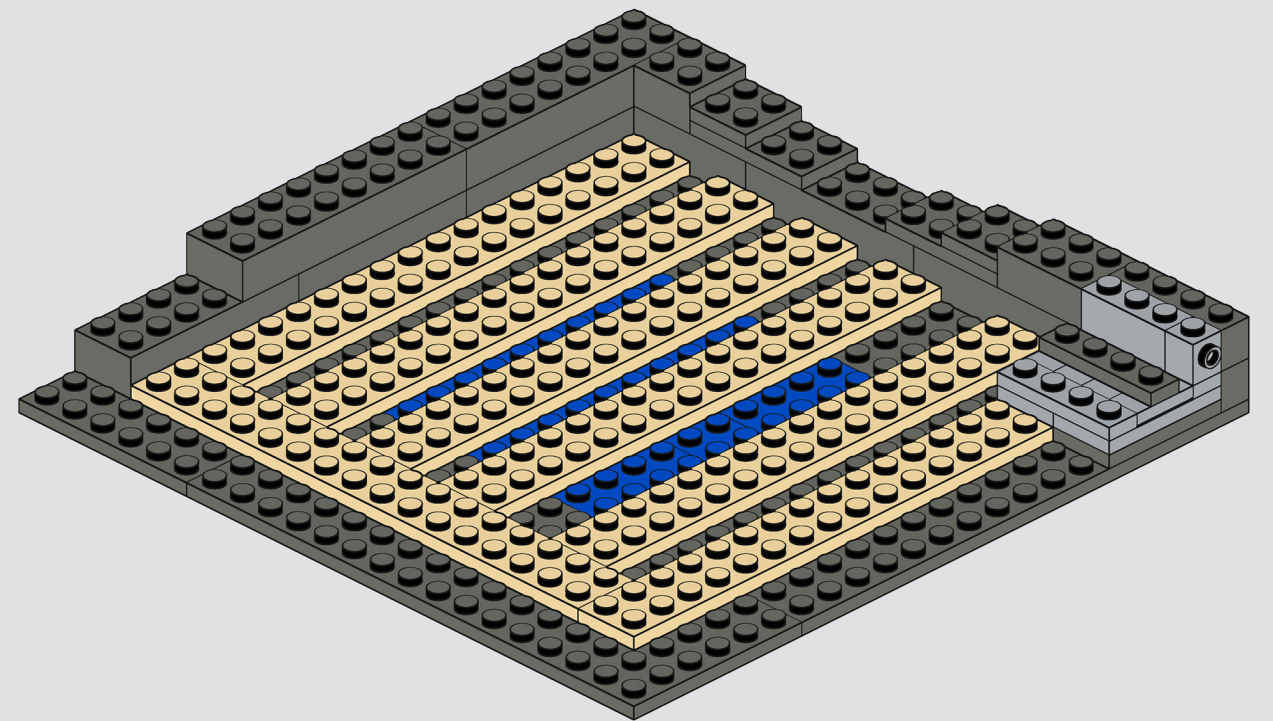
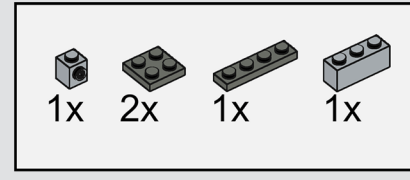

7

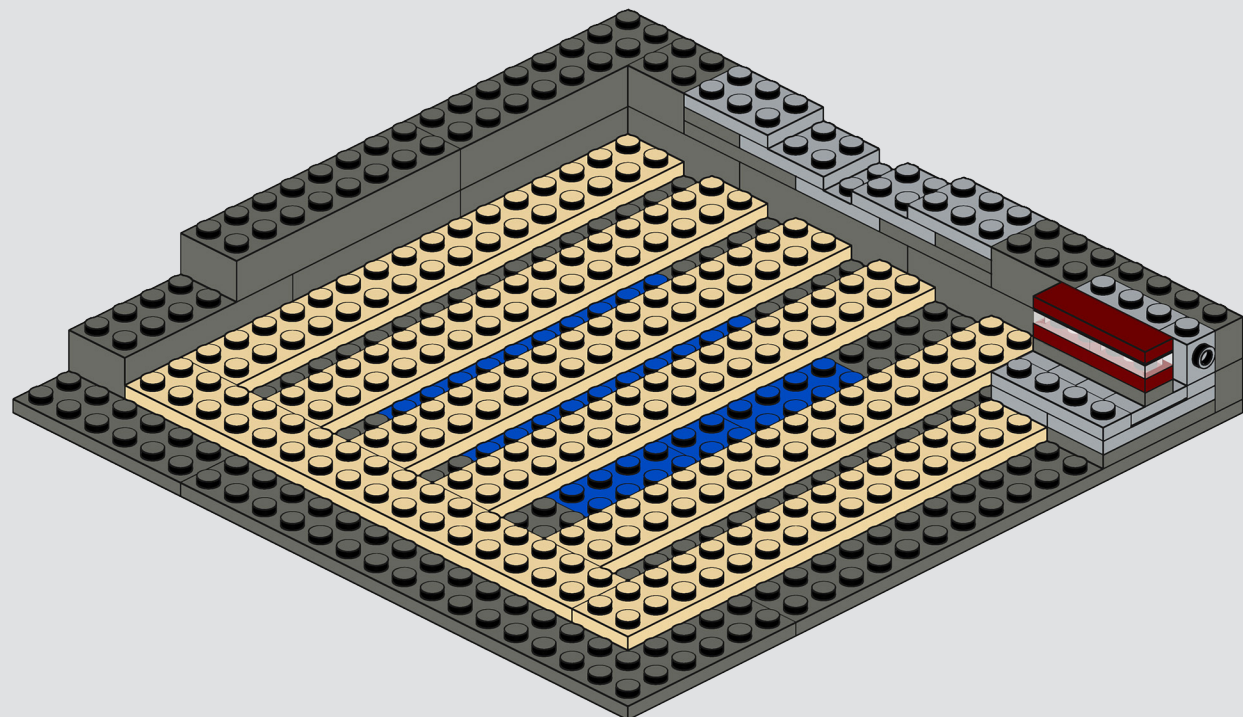
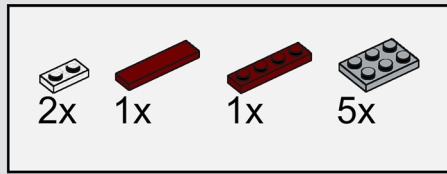

8

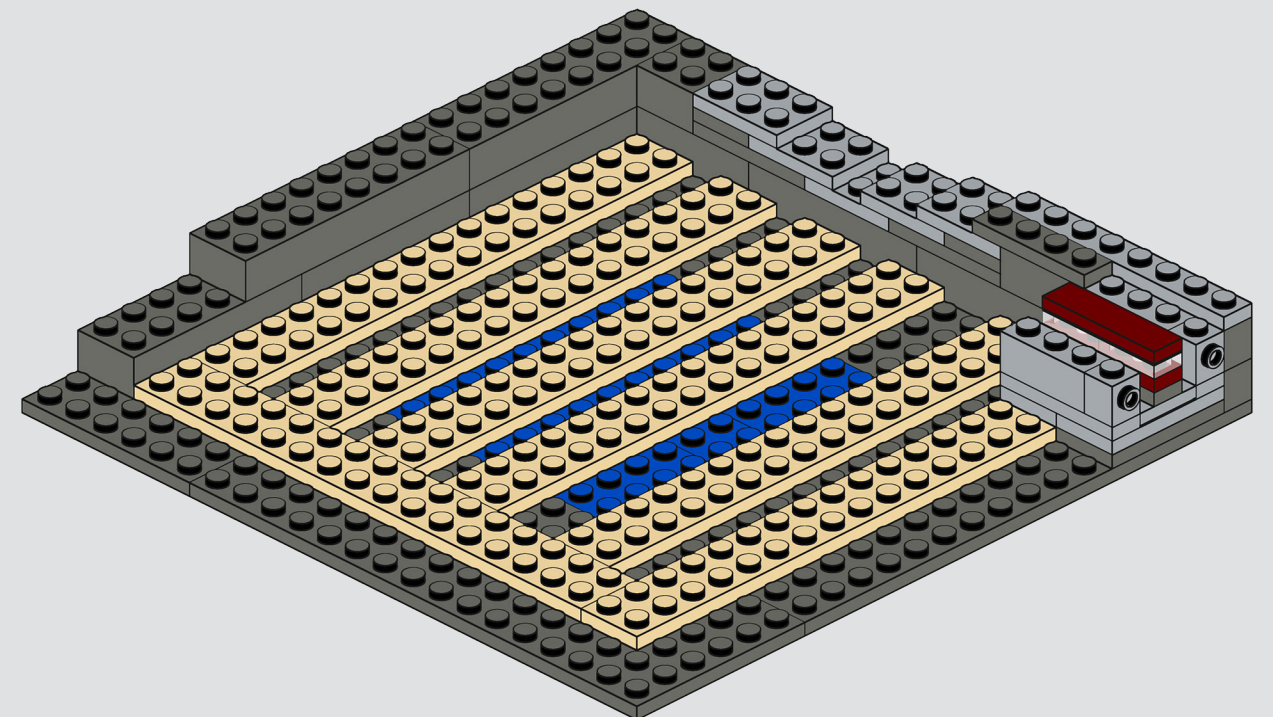
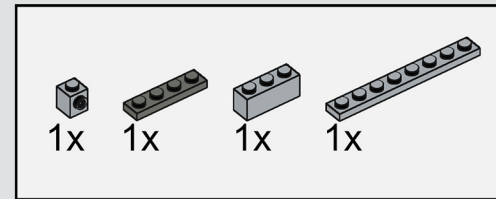

9

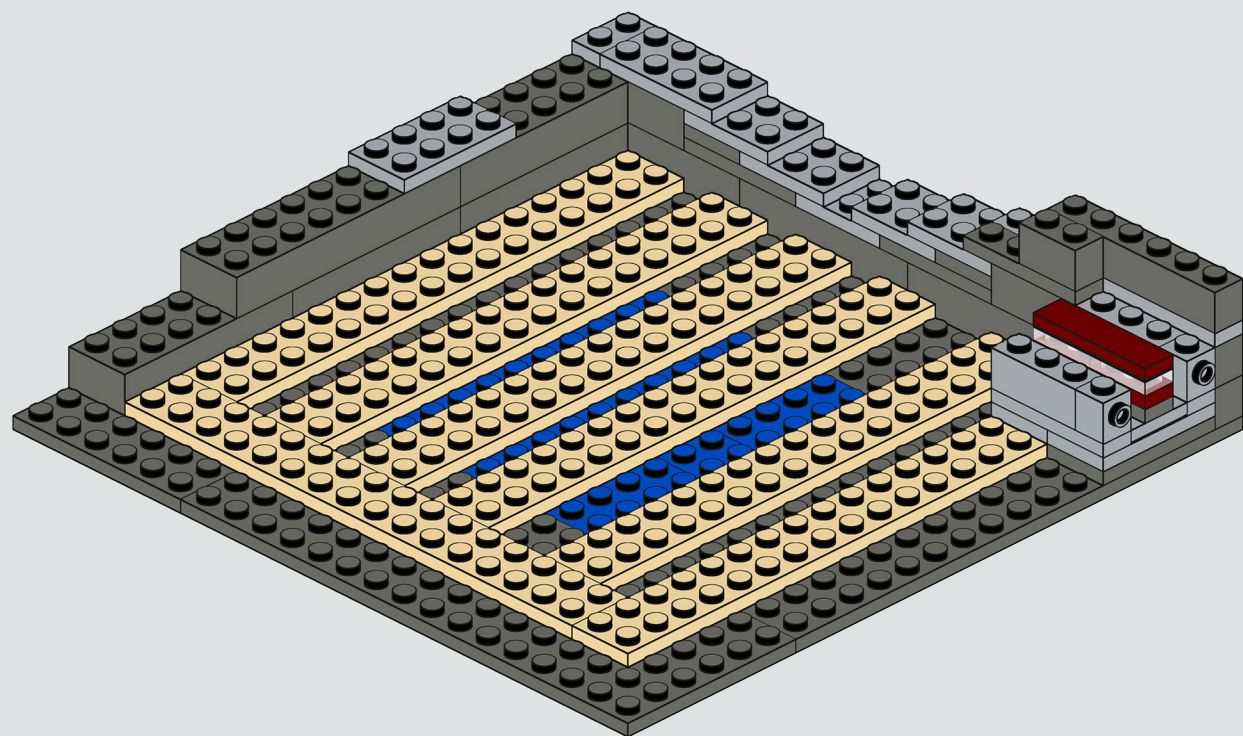
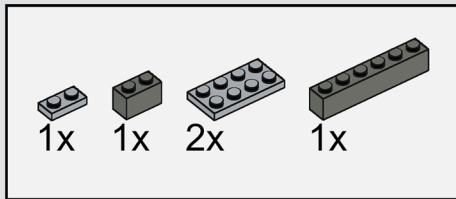

10

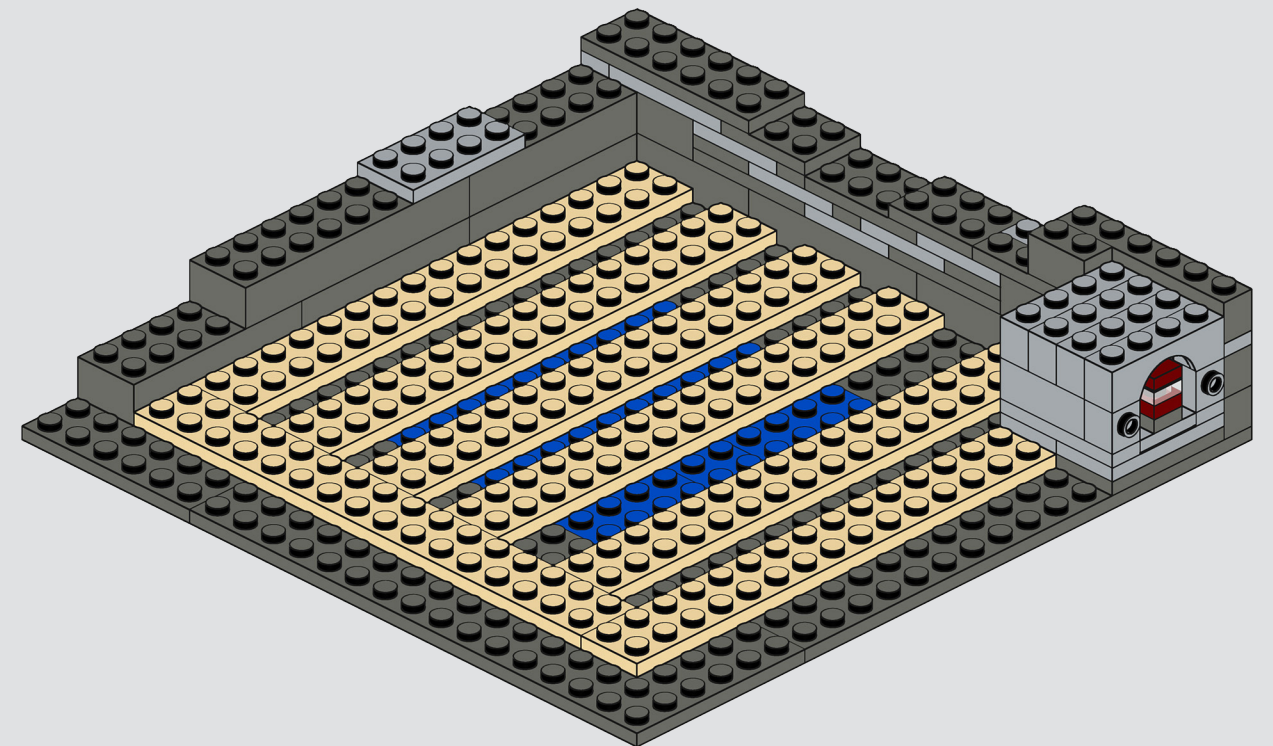
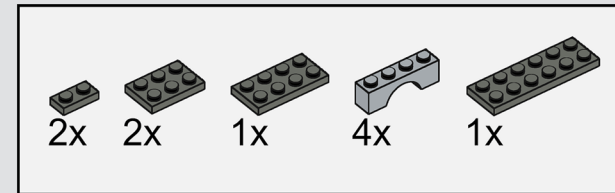

11

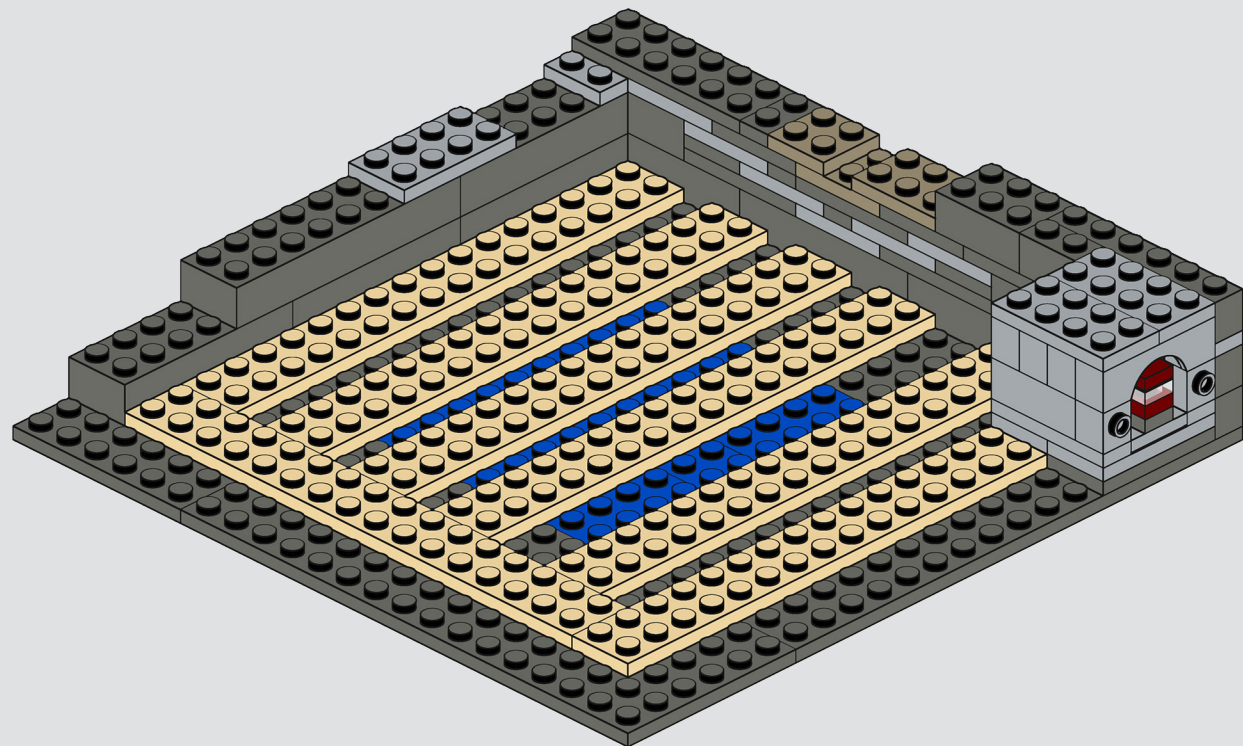
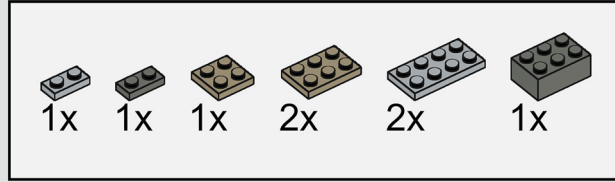

12

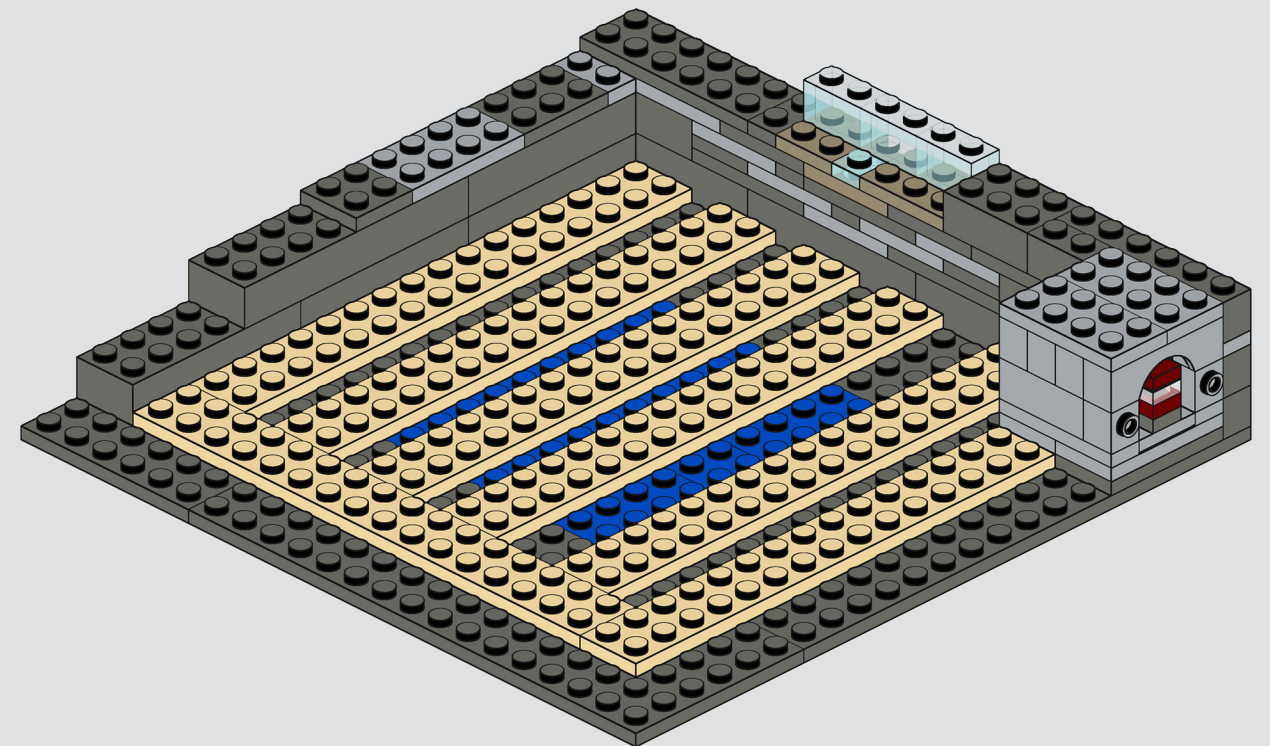
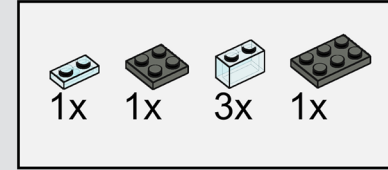

13

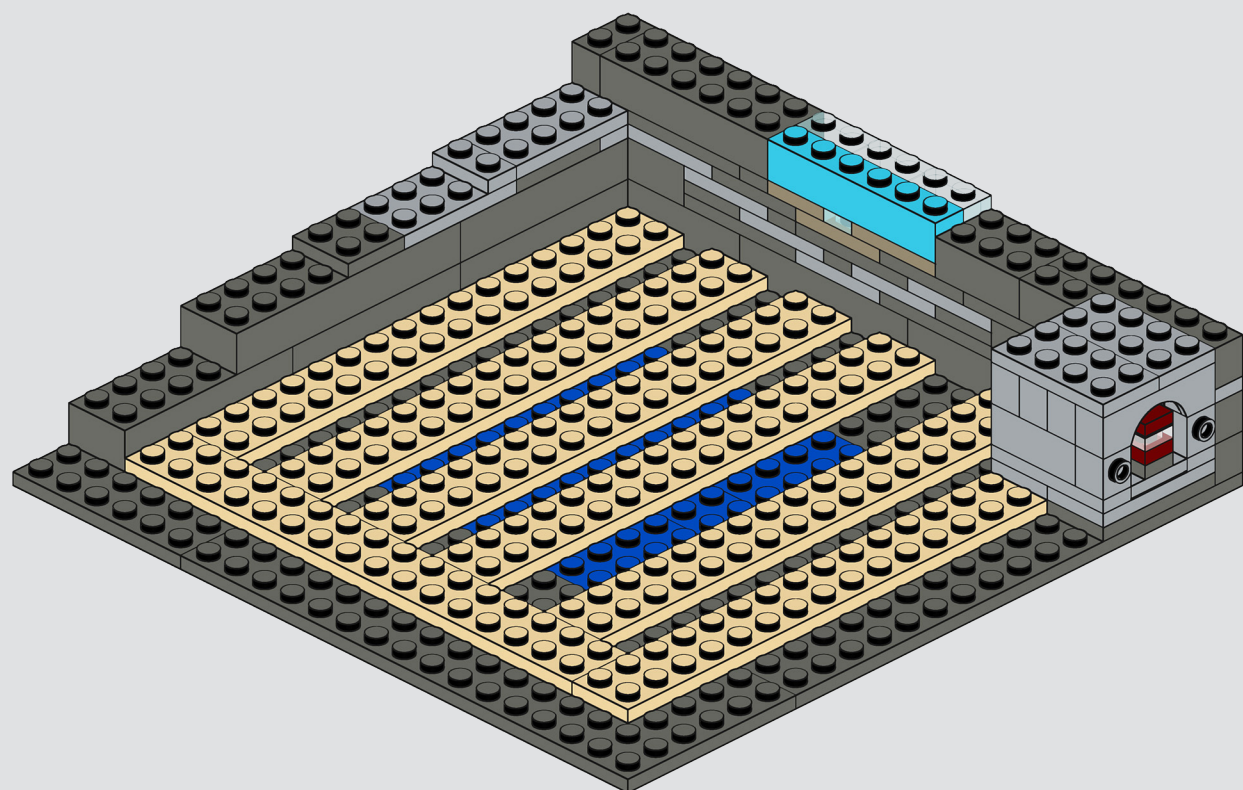
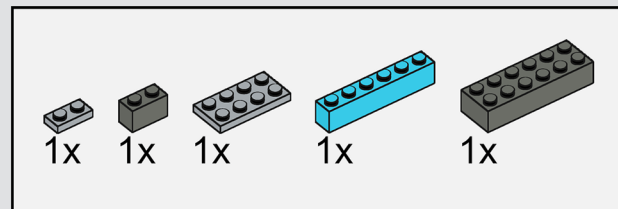

14

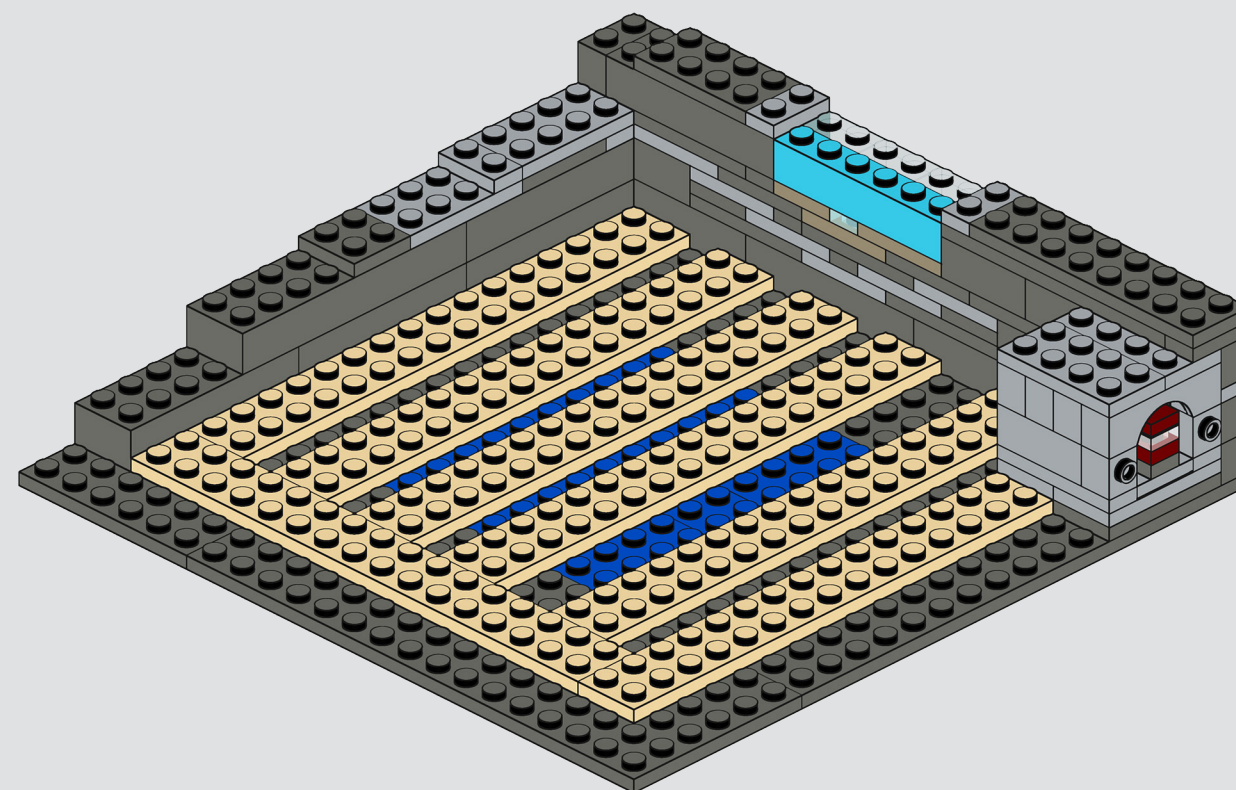
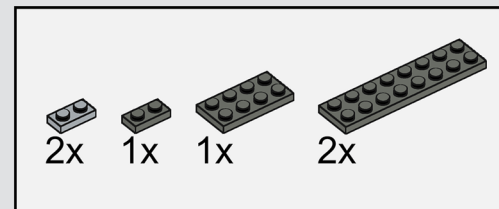

15

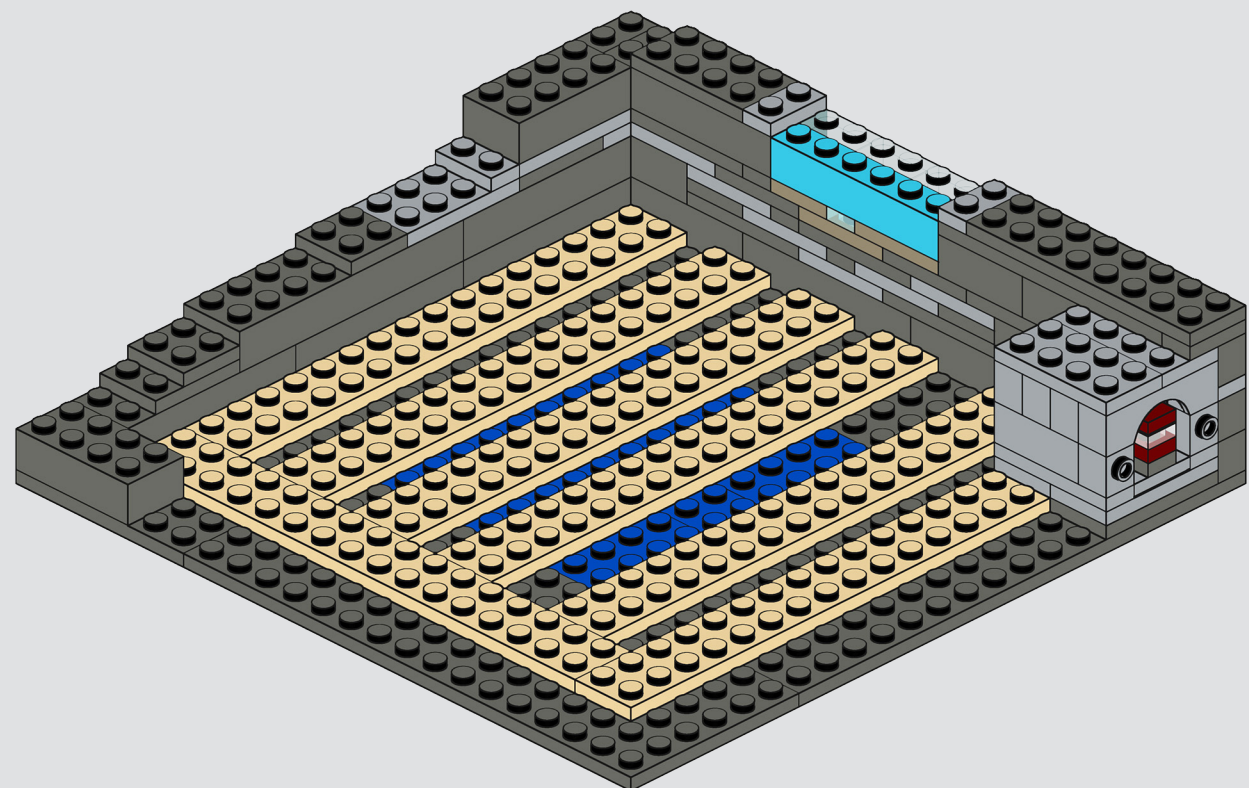
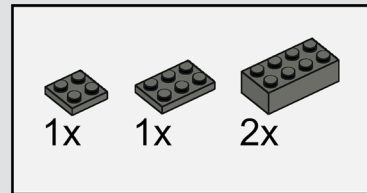

16

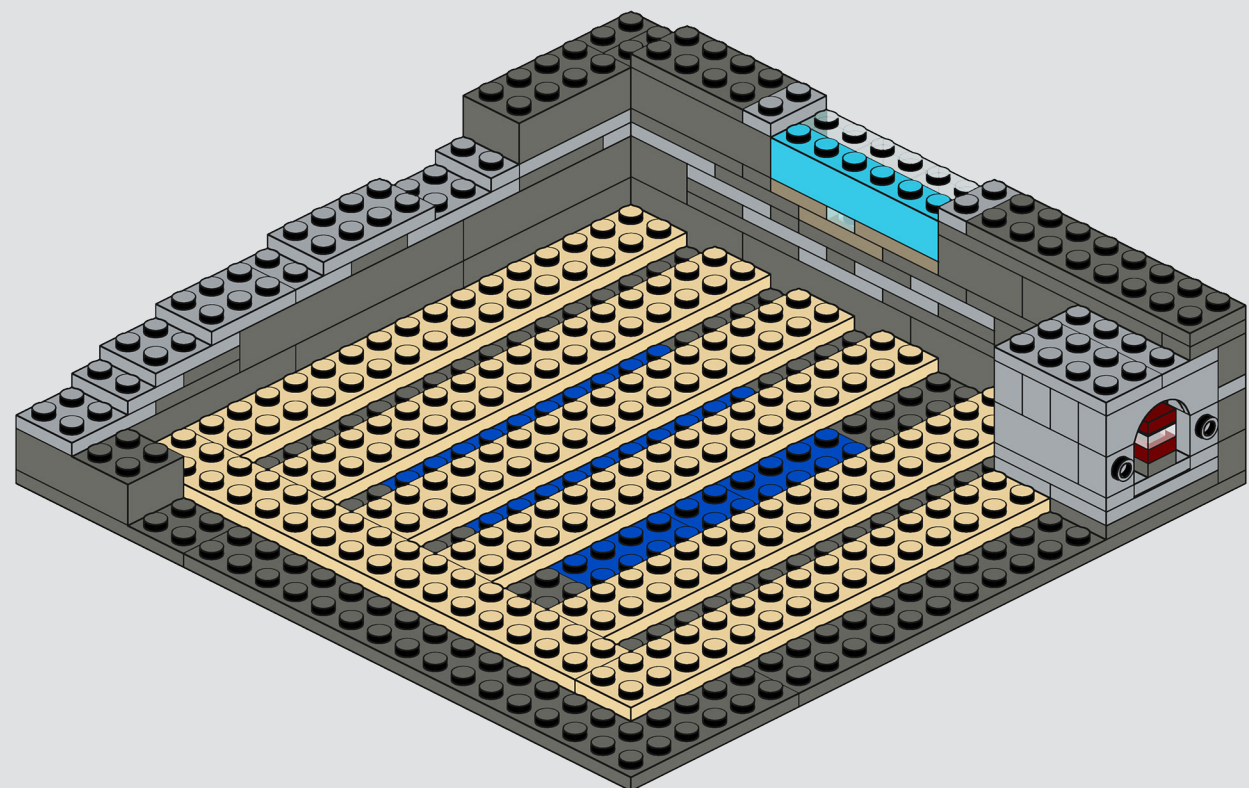
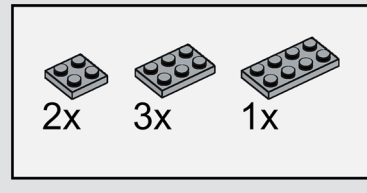

17

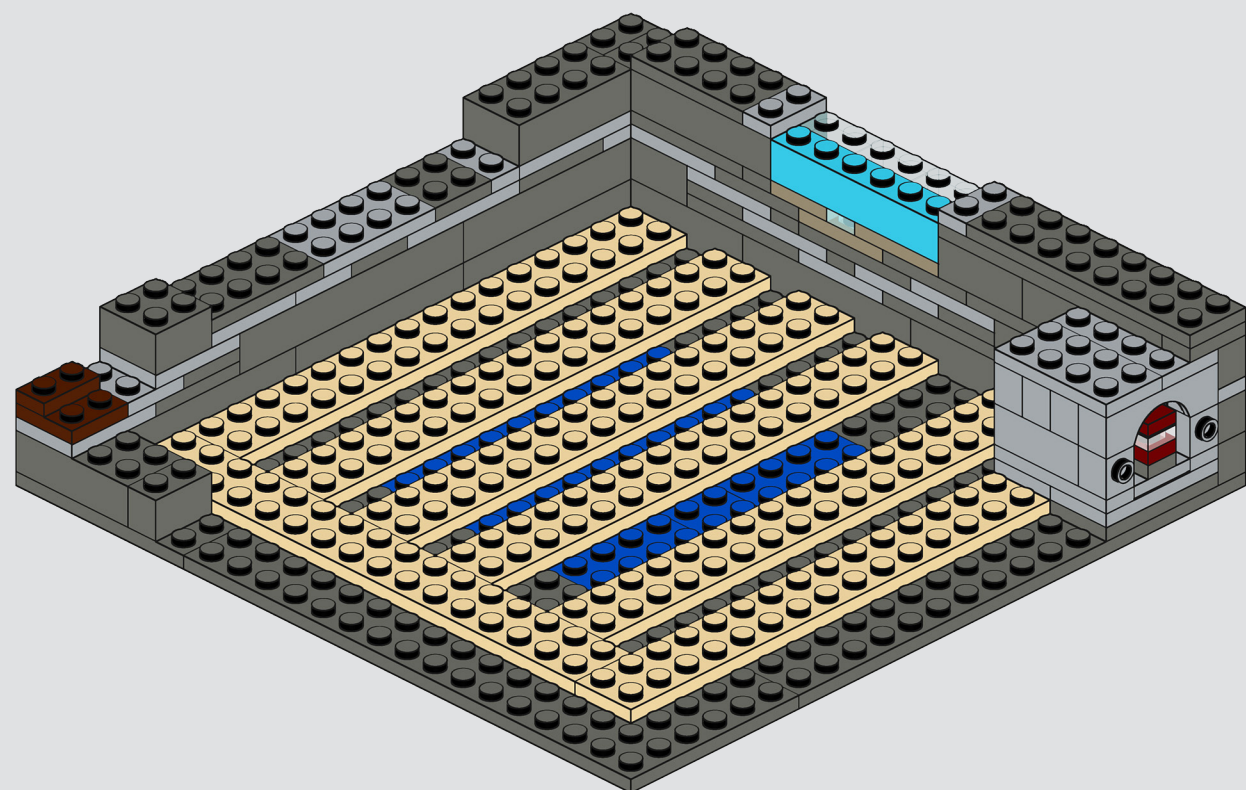
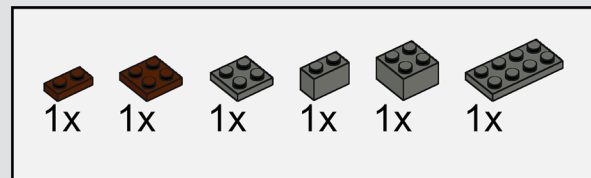

18

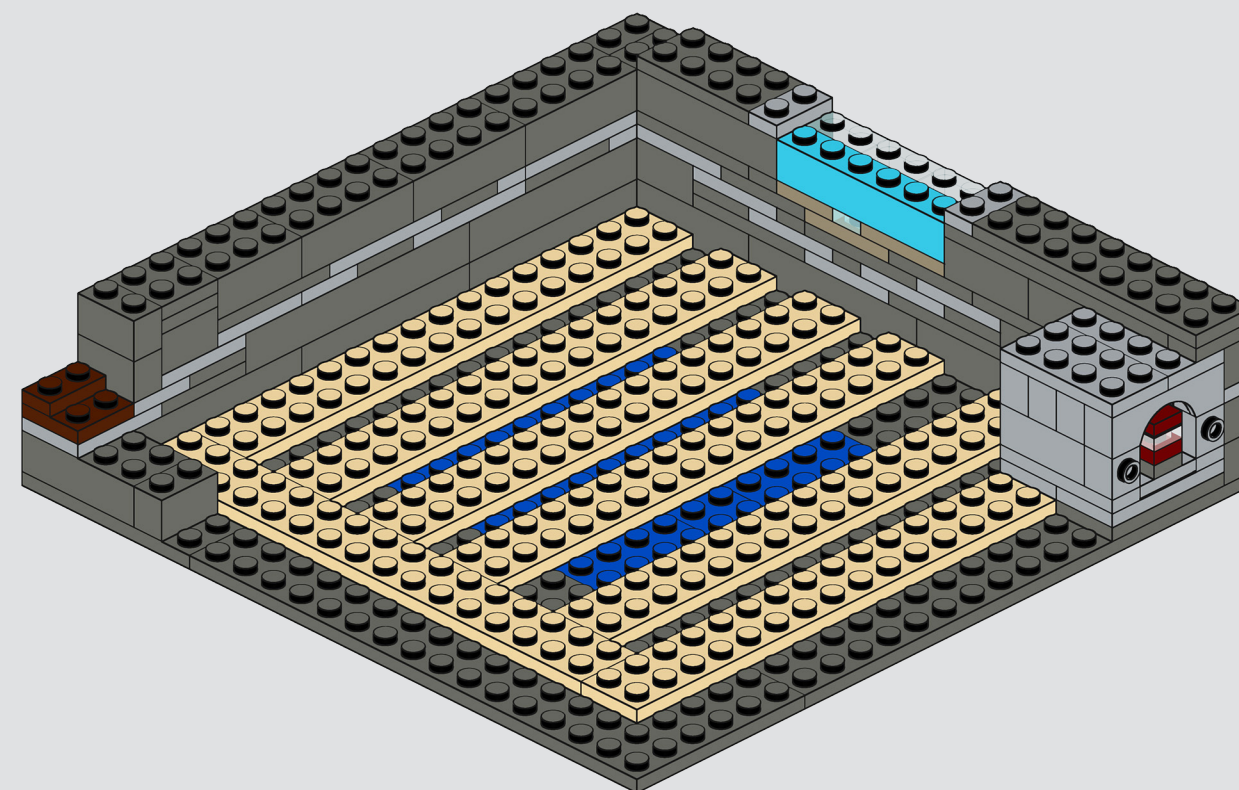
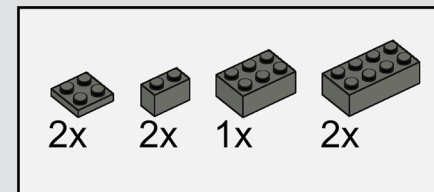

19

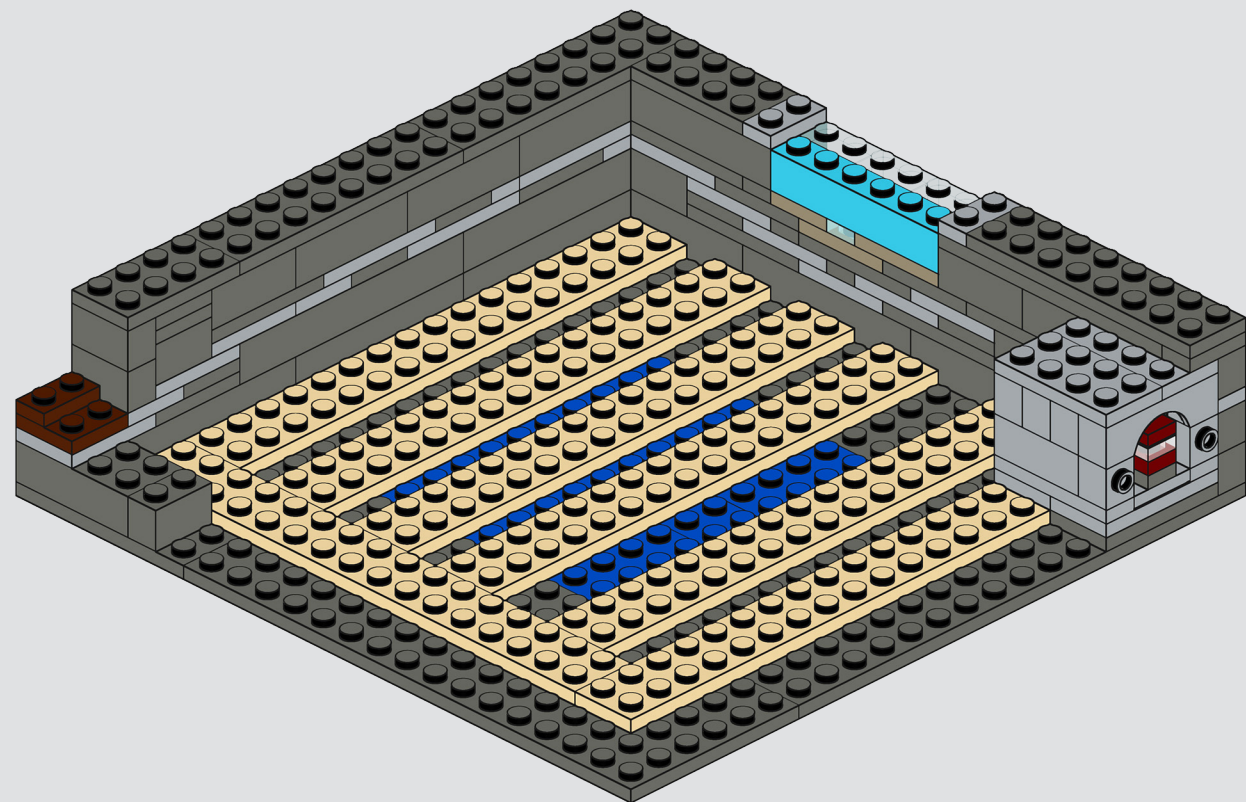
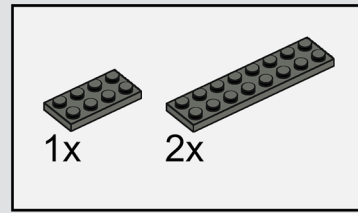

20

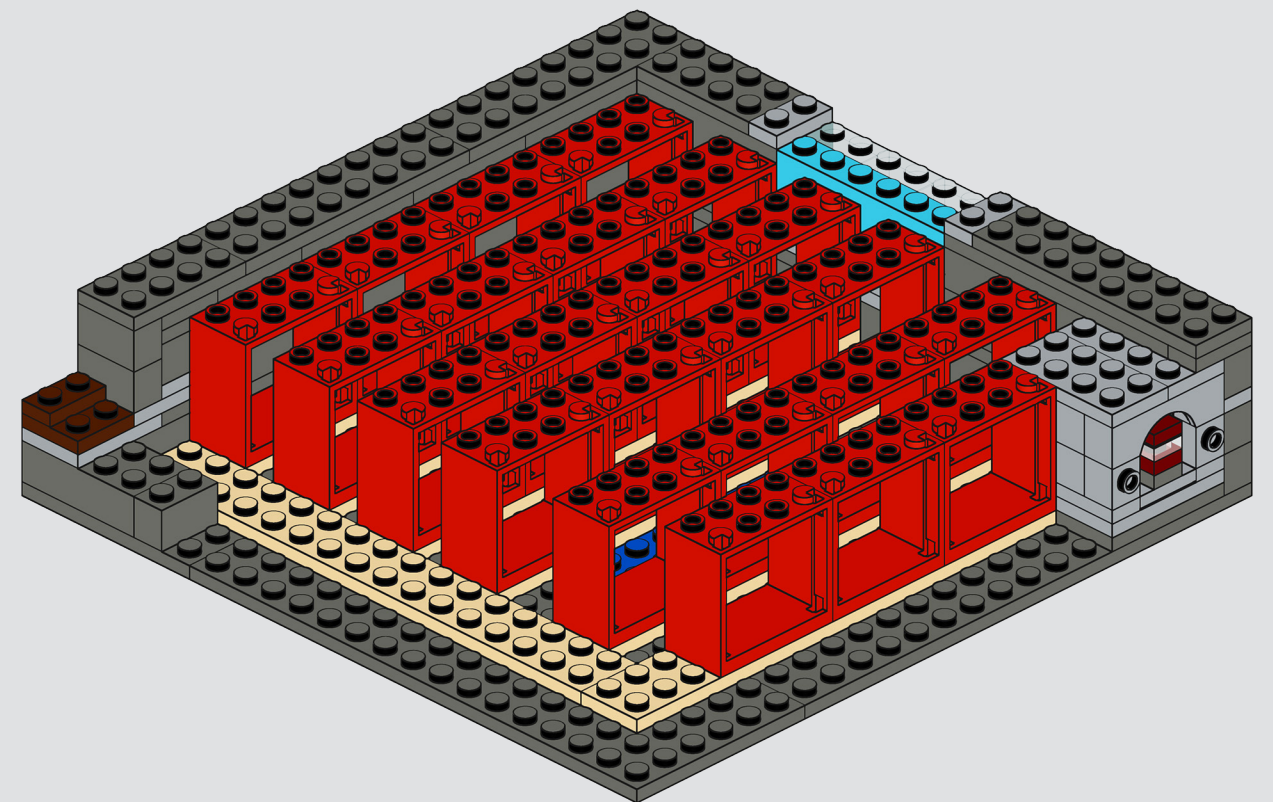
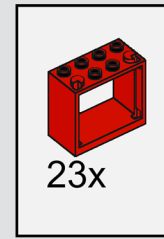

21

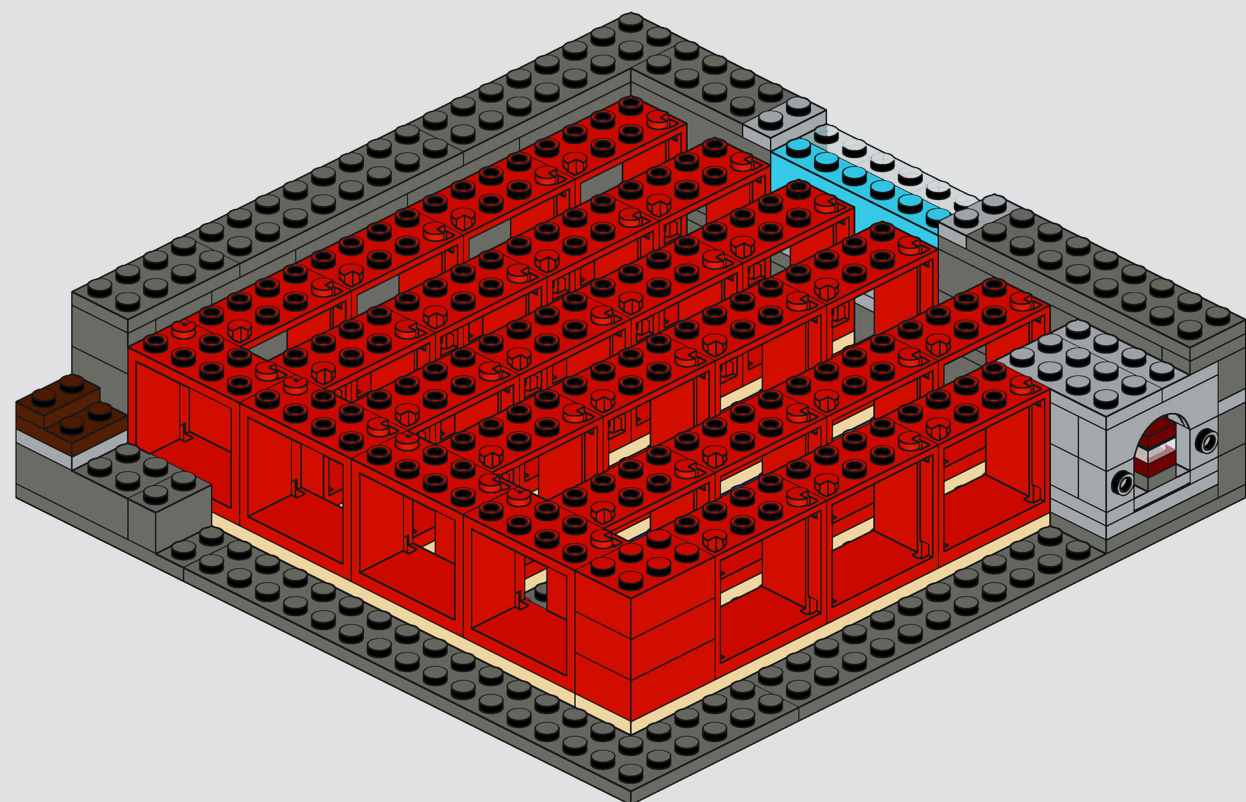
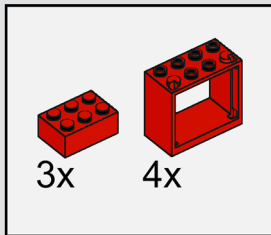

22

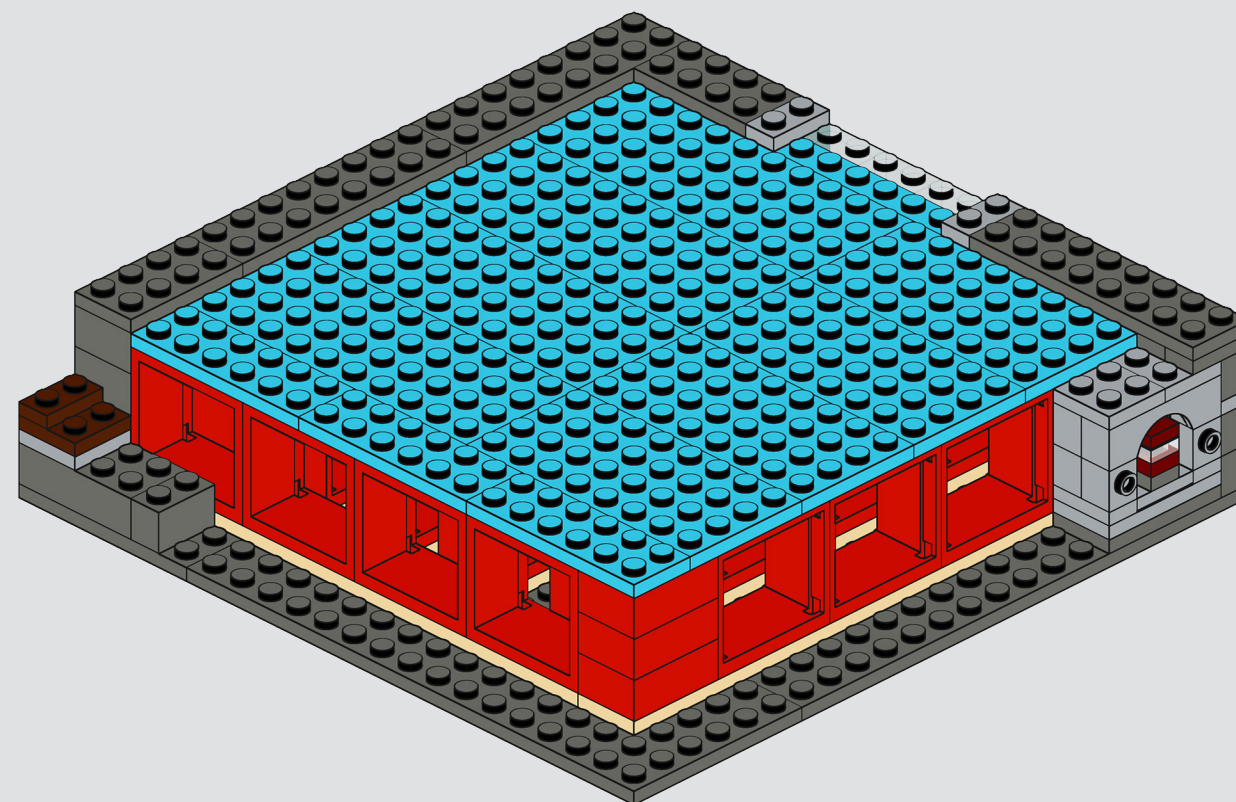
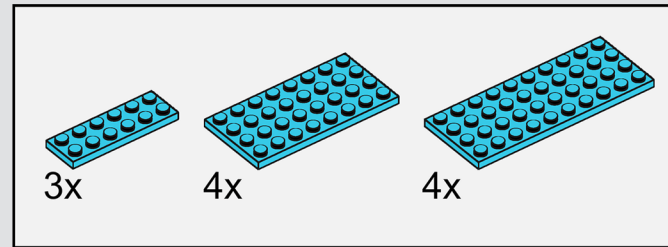

23

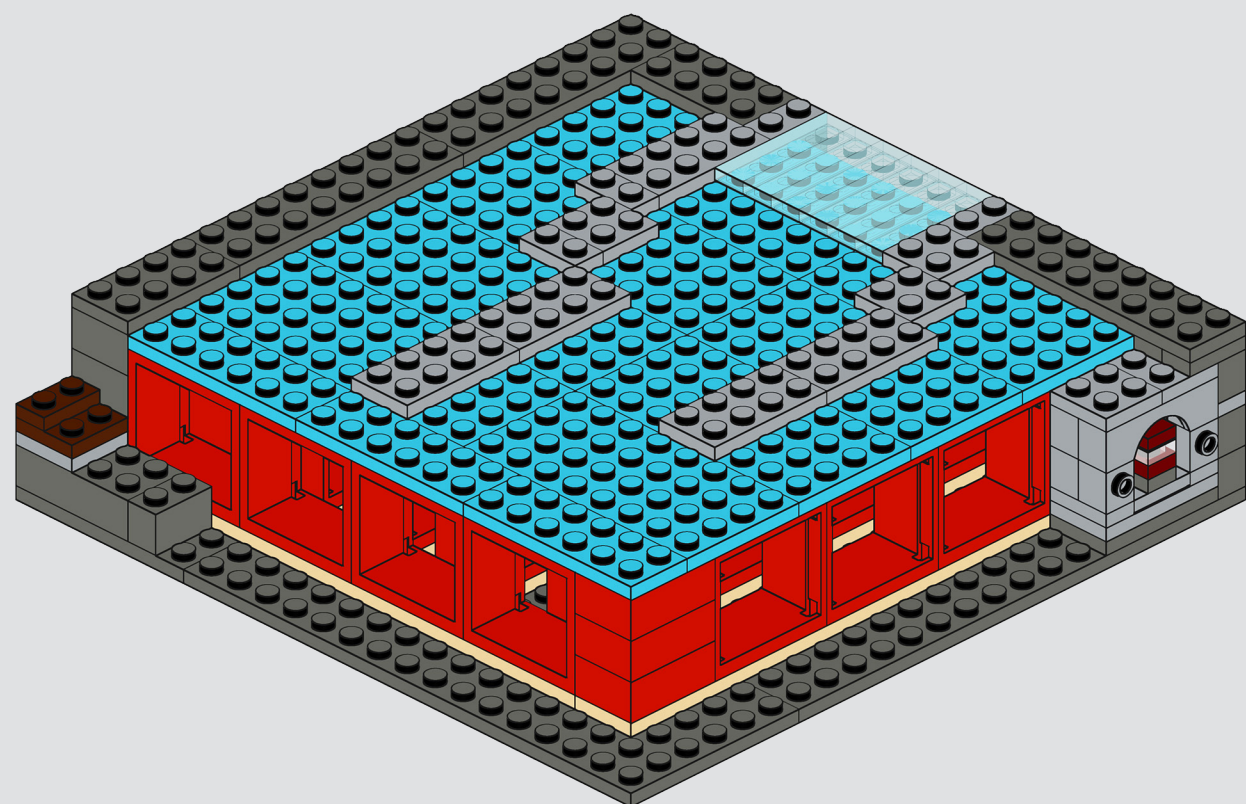
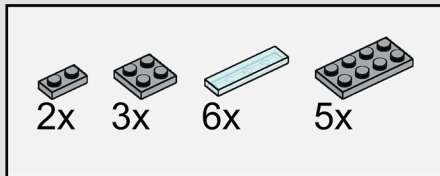

24

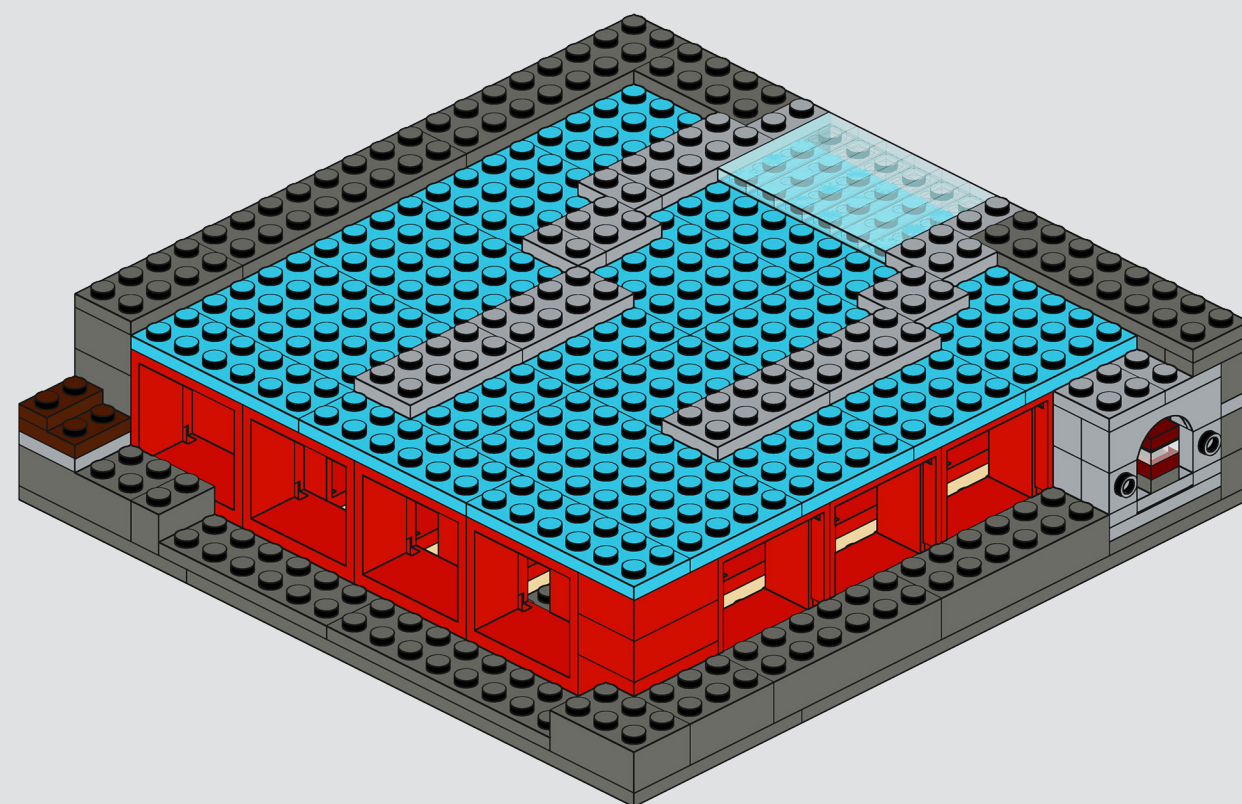
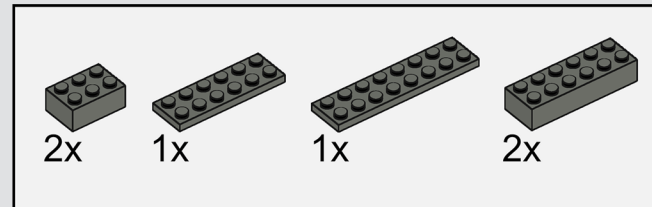

25

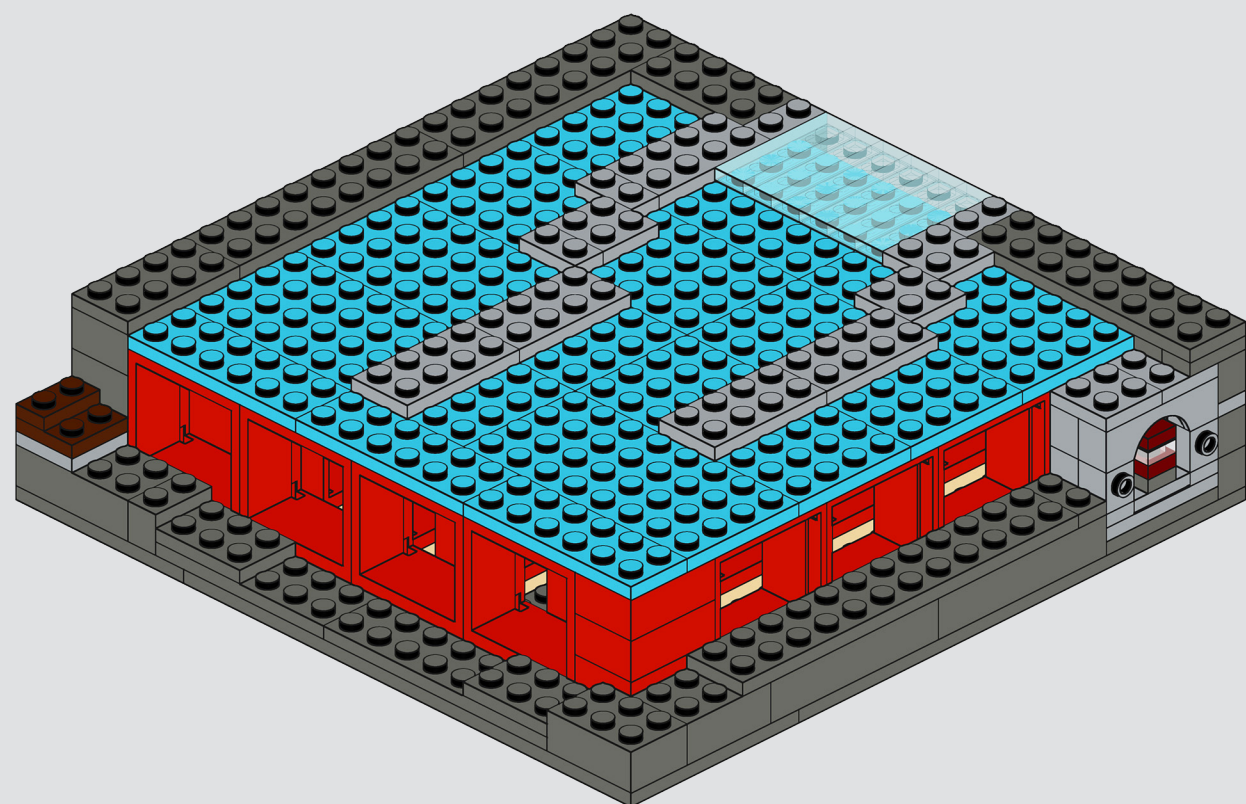
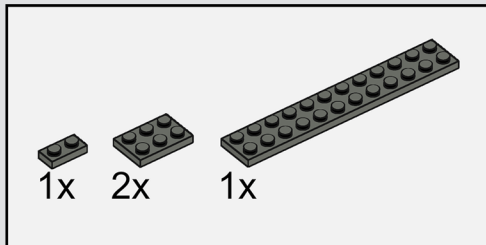

26

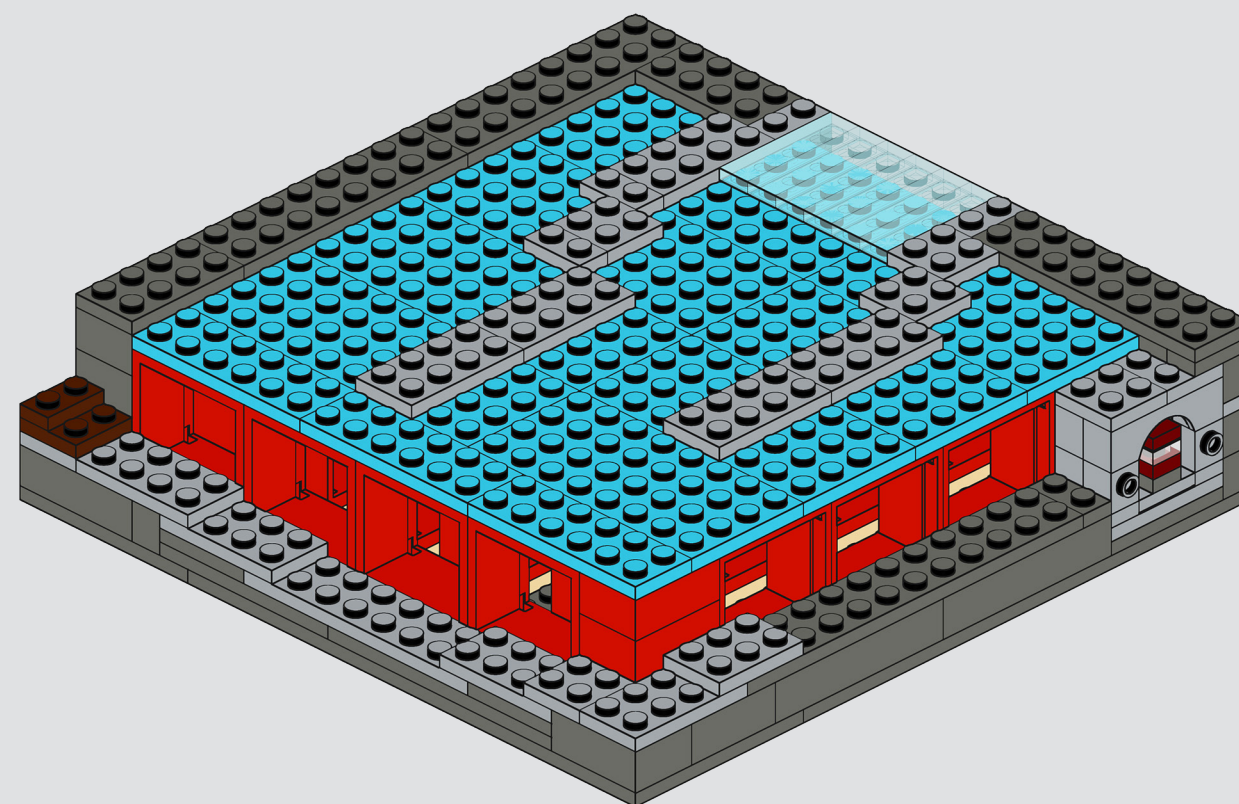
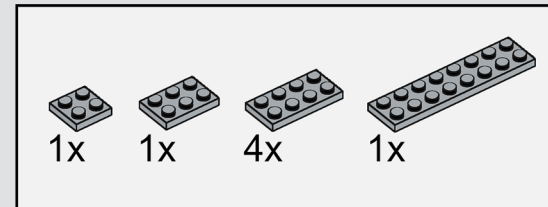

27

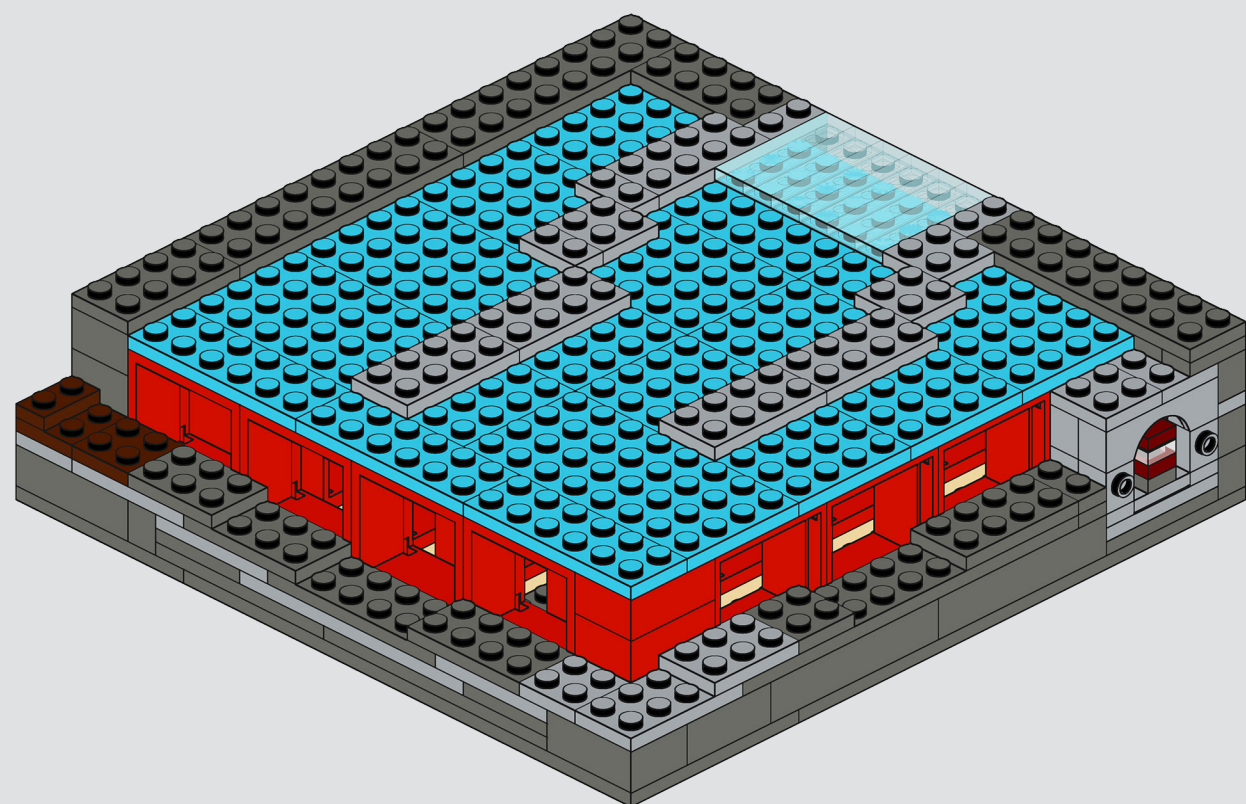
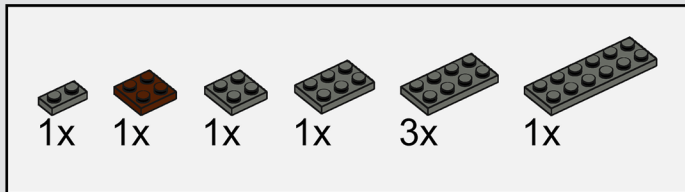

28

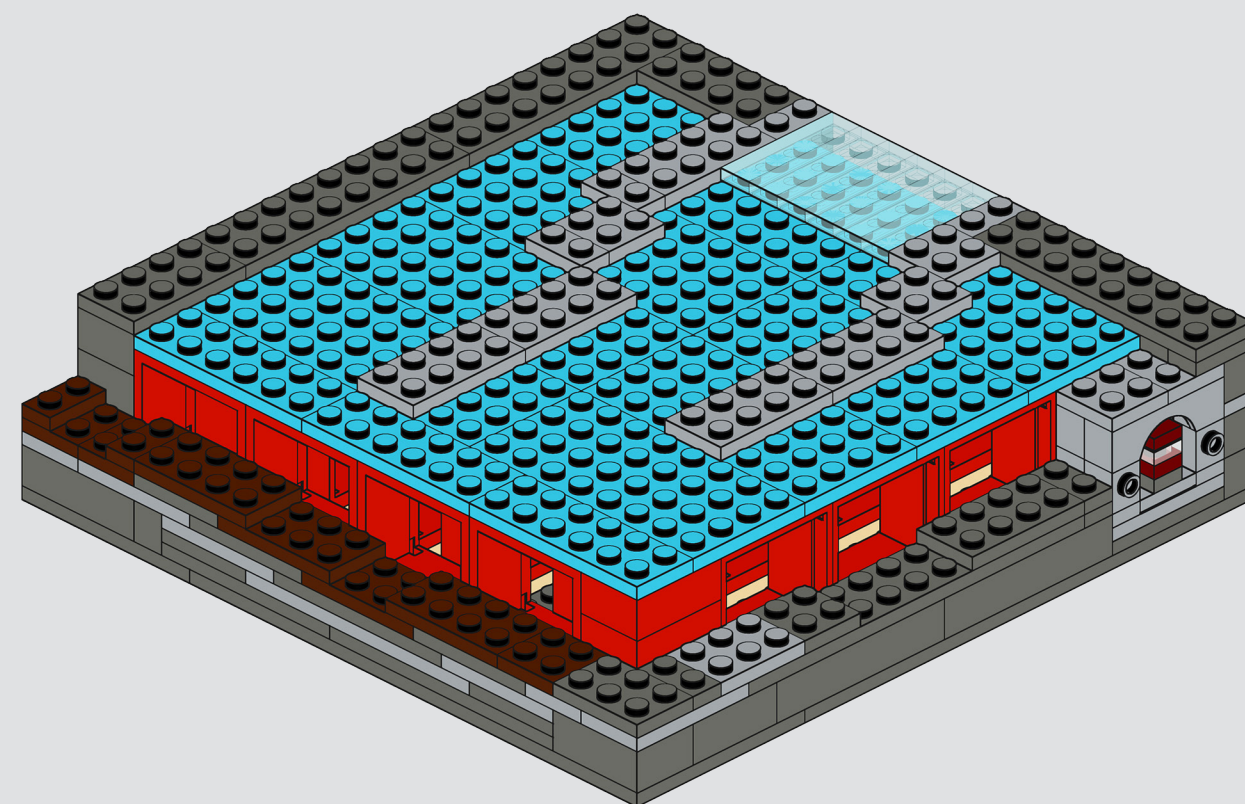
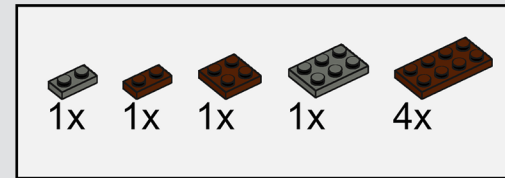

29

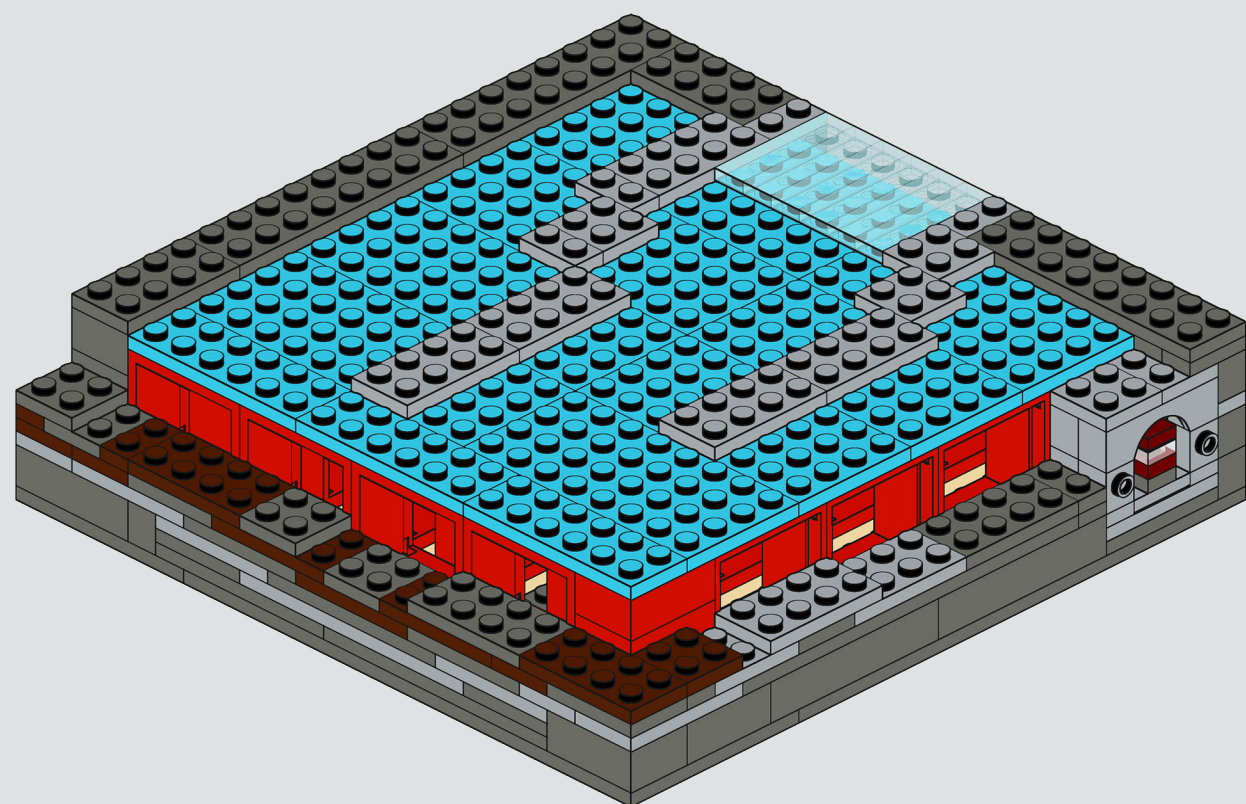
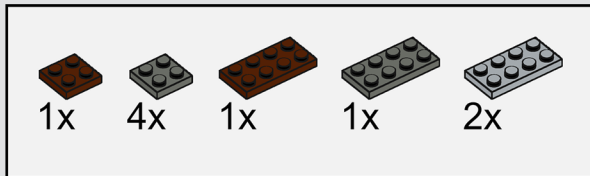

30

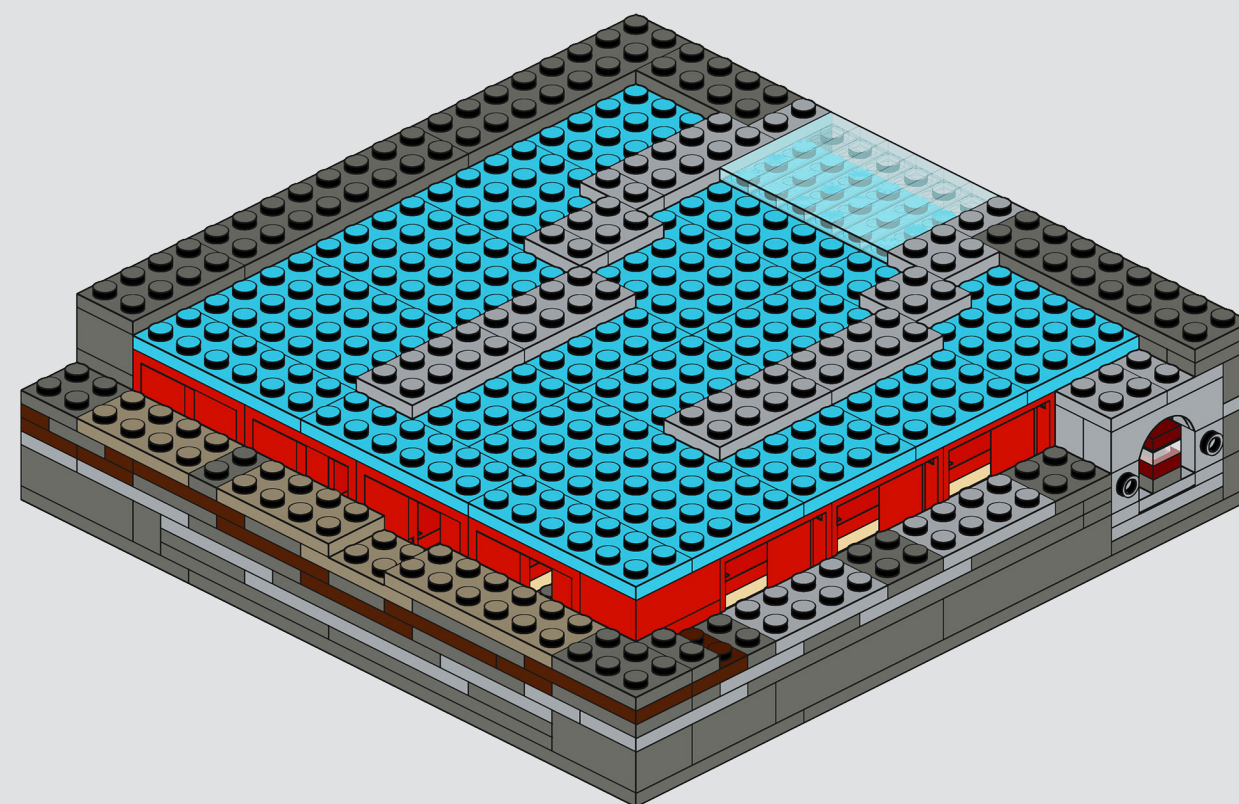
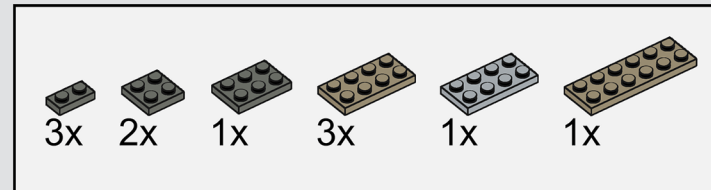

31

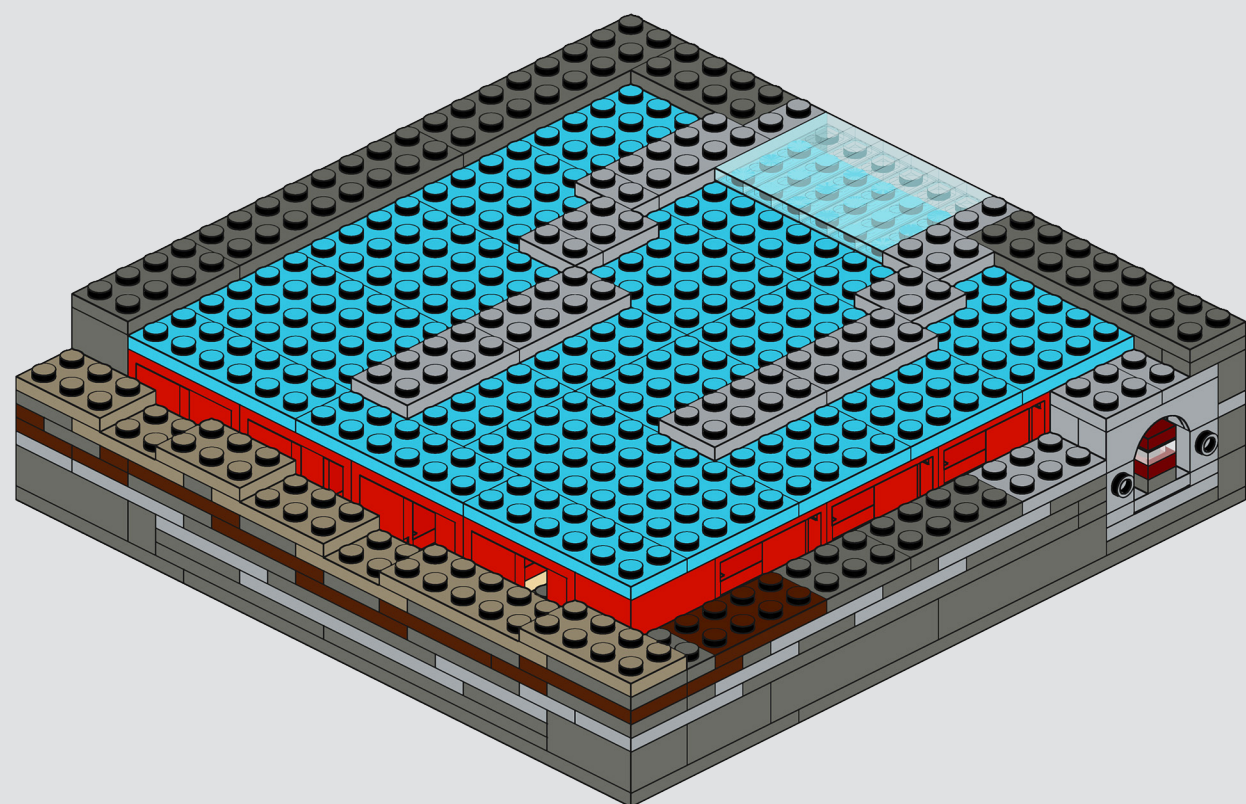
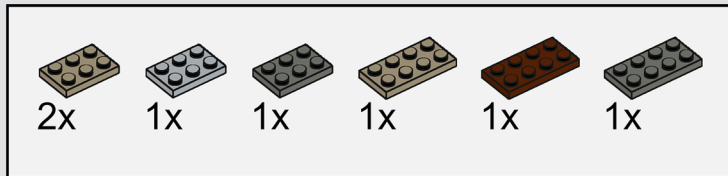

32

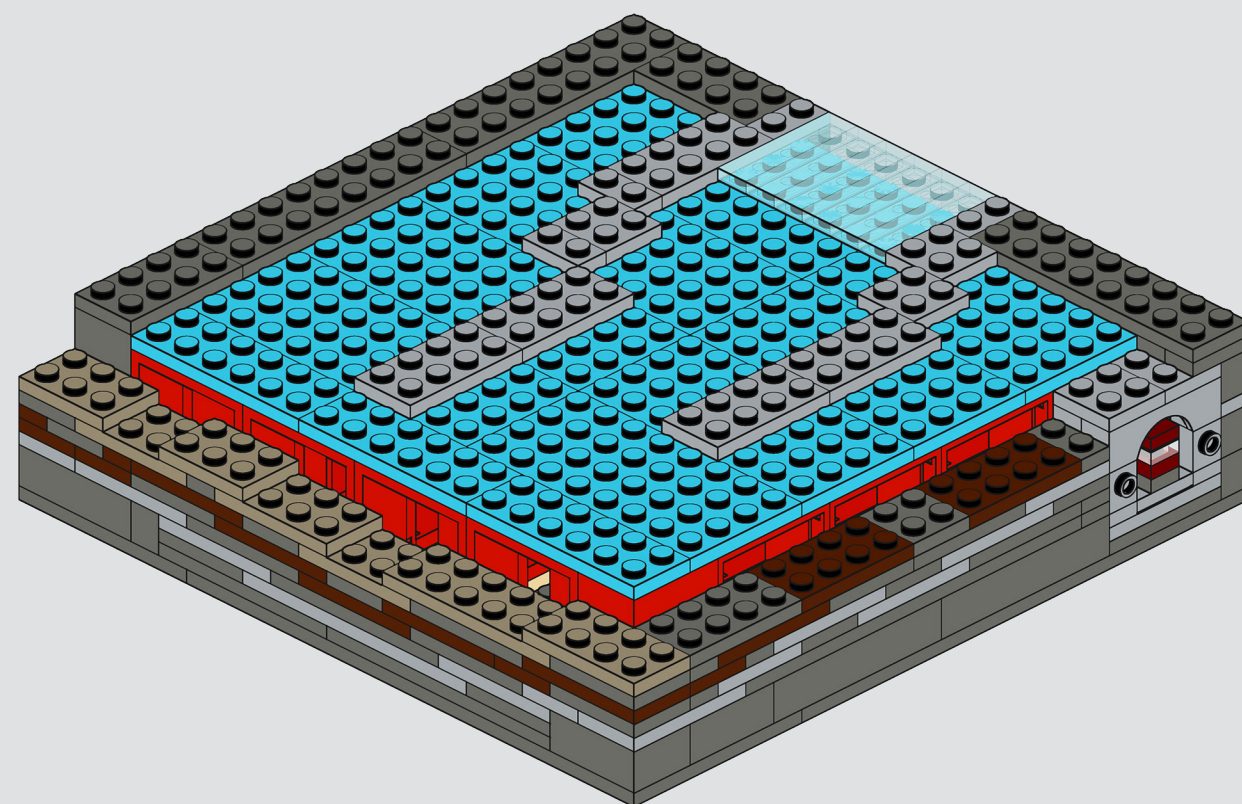
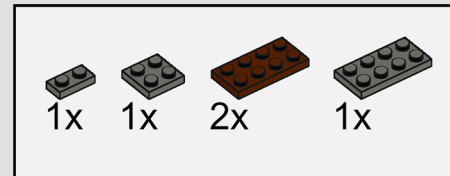

33

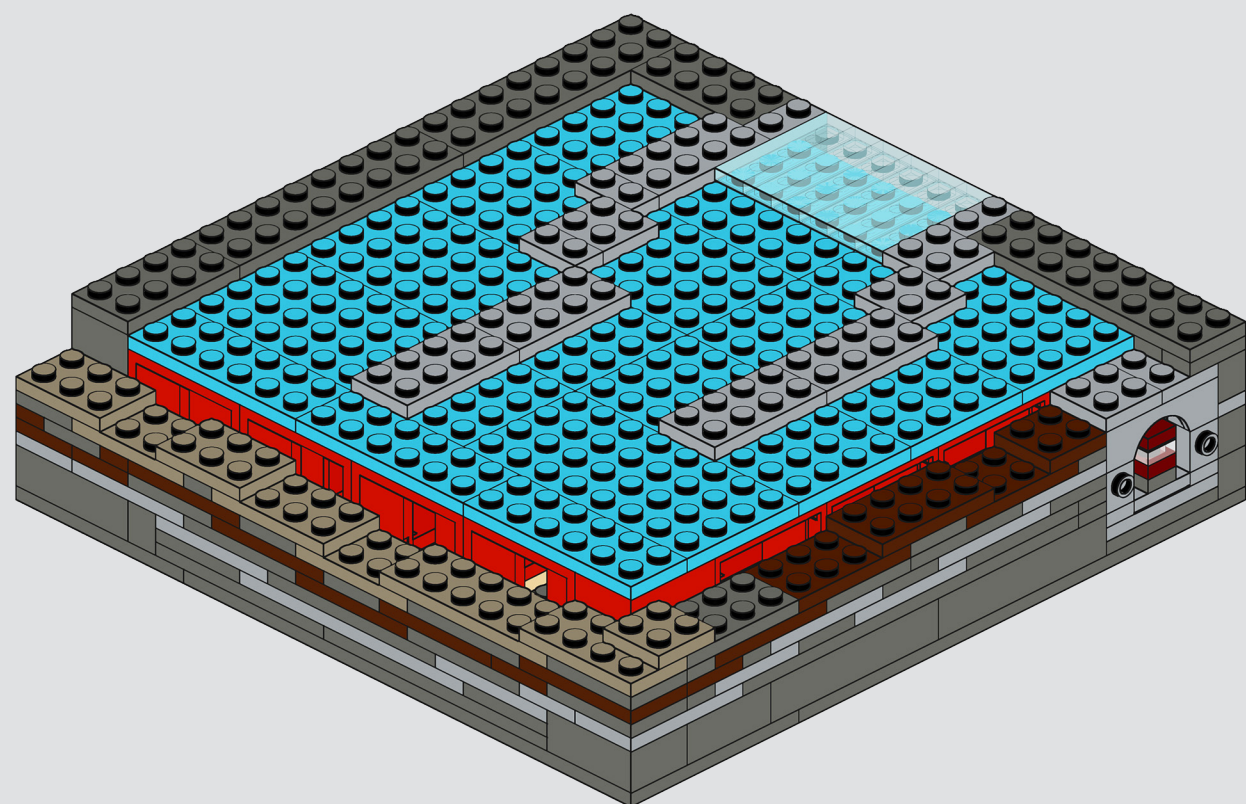

34

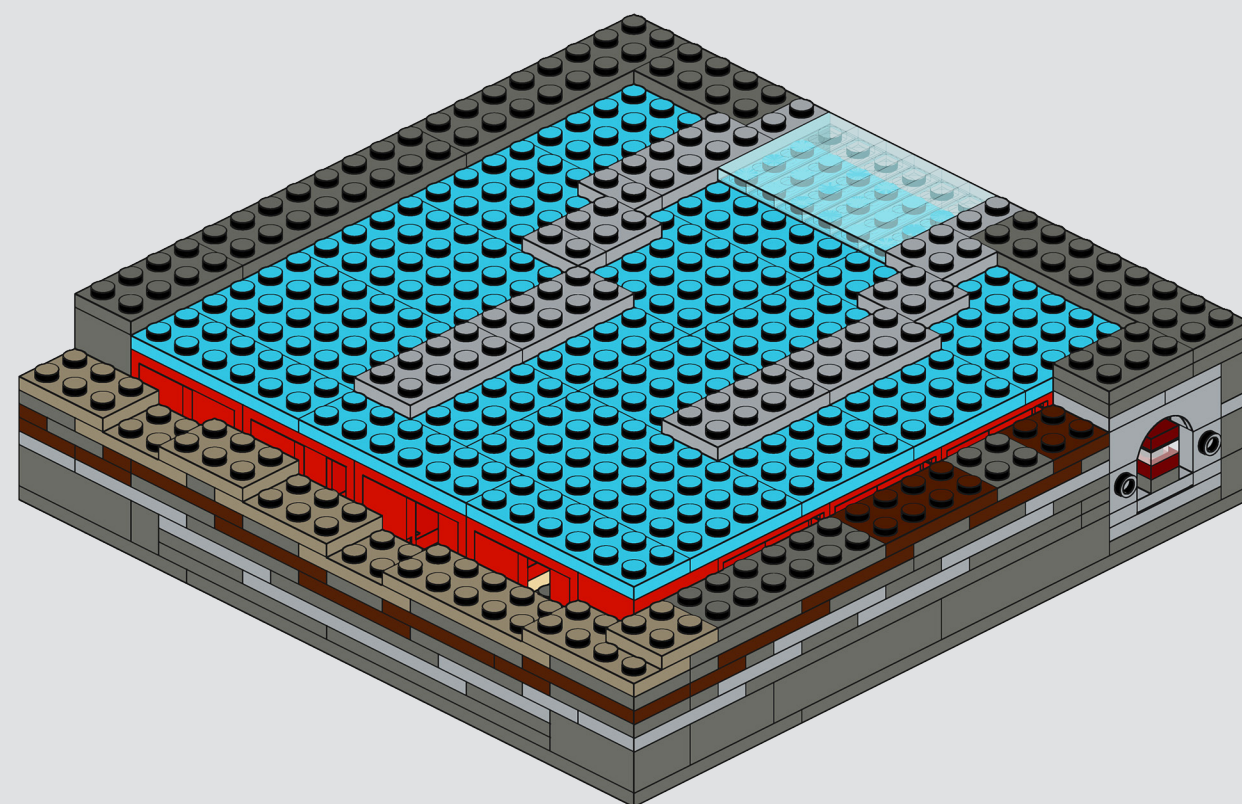
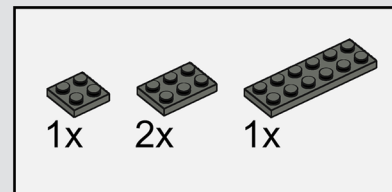

35

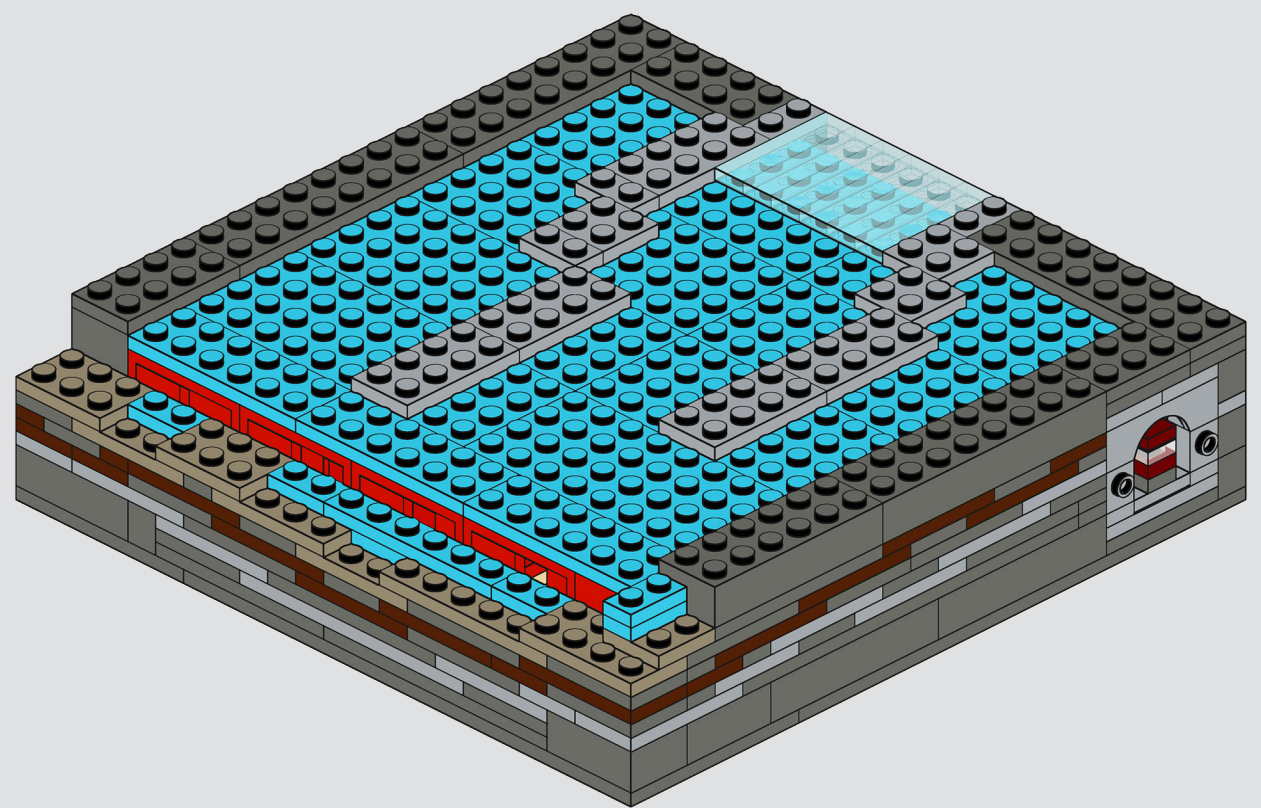
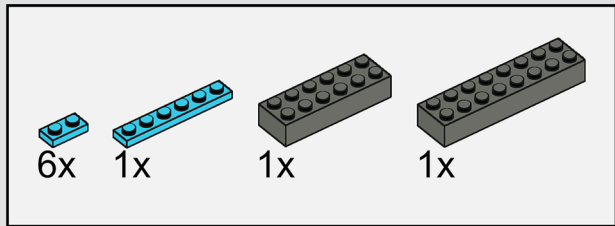

36

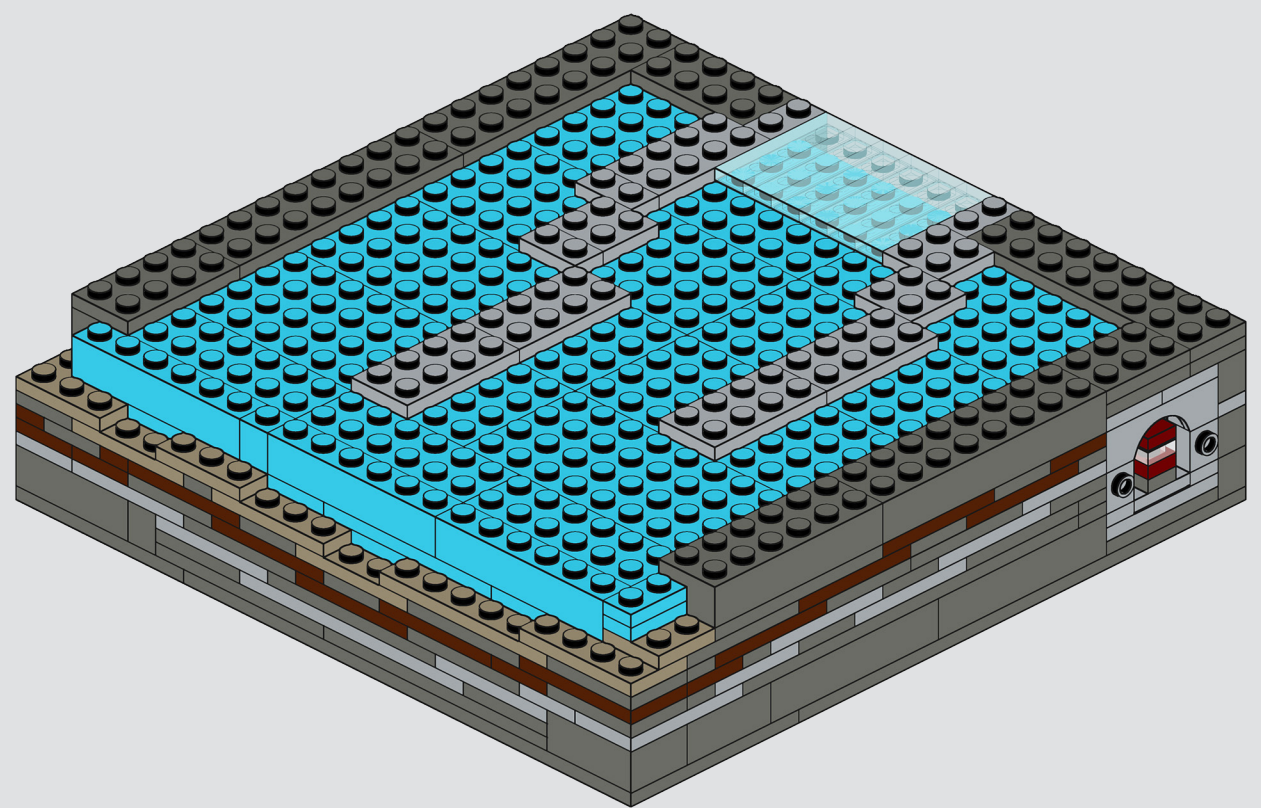
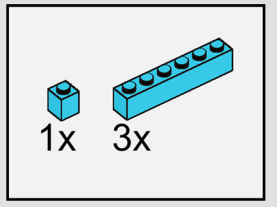

37

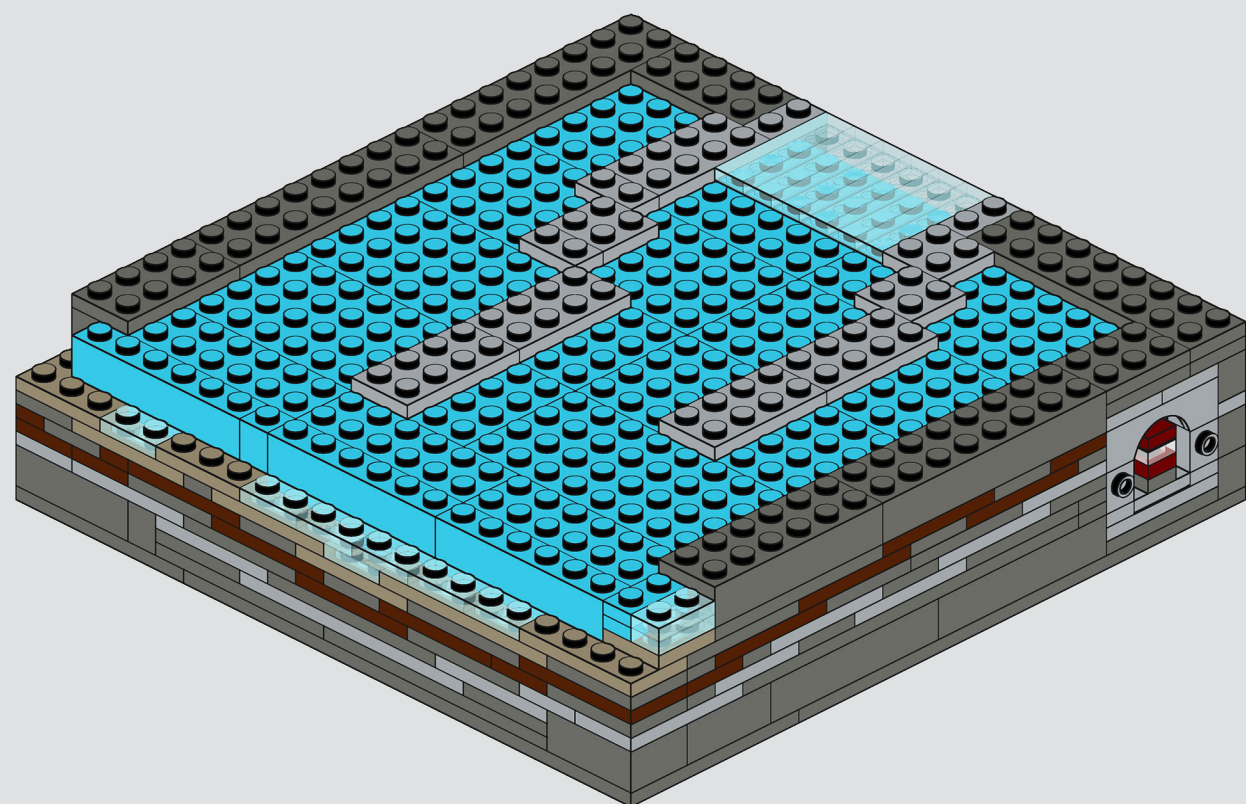

38

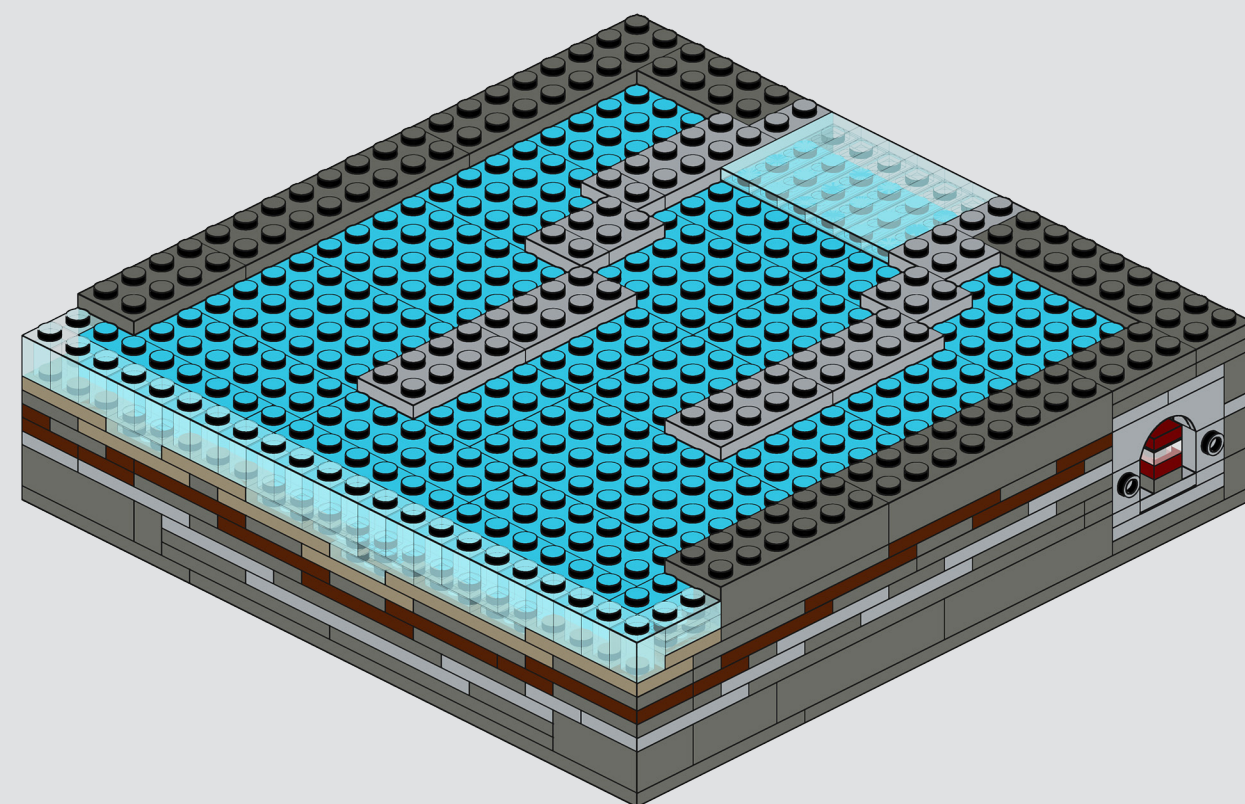
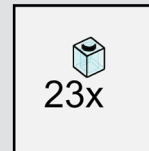

39

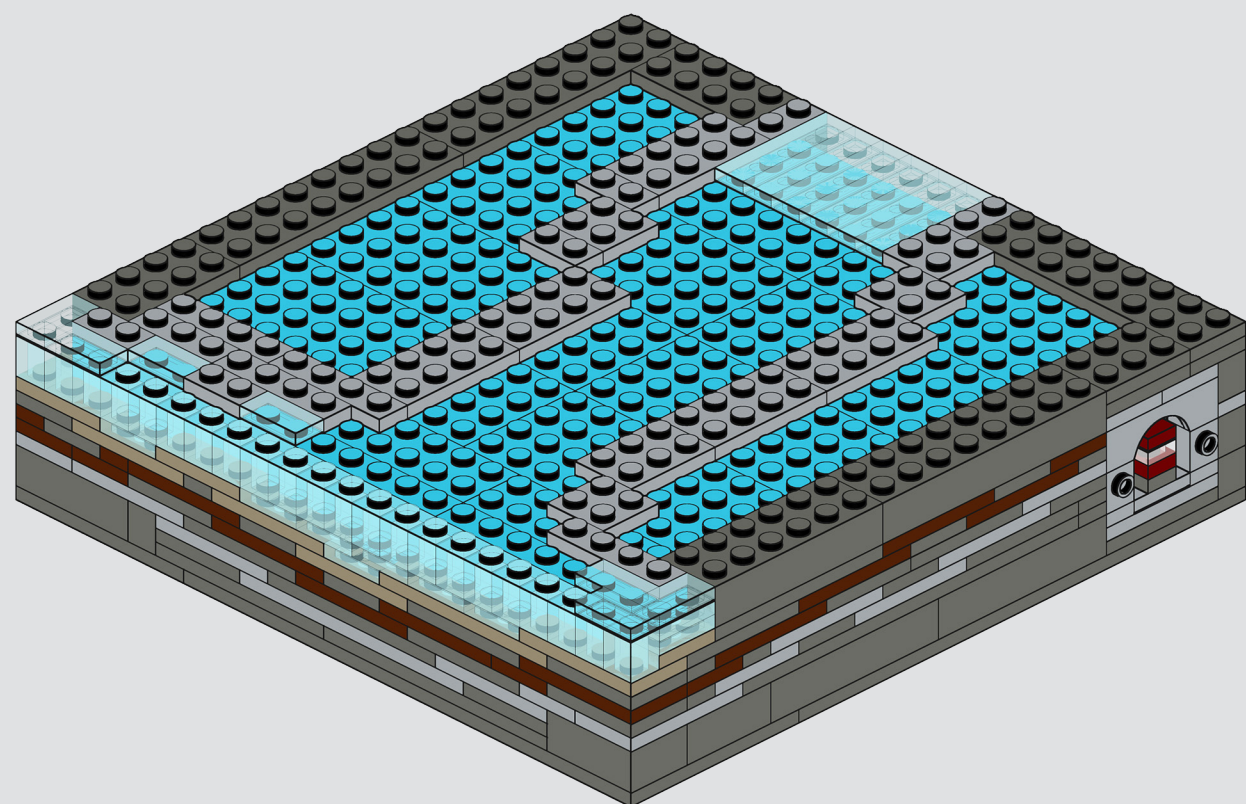
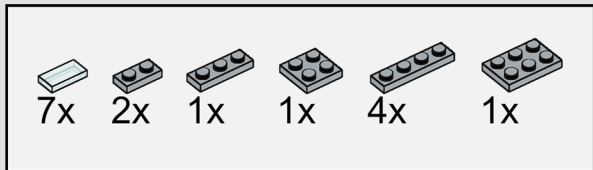

40

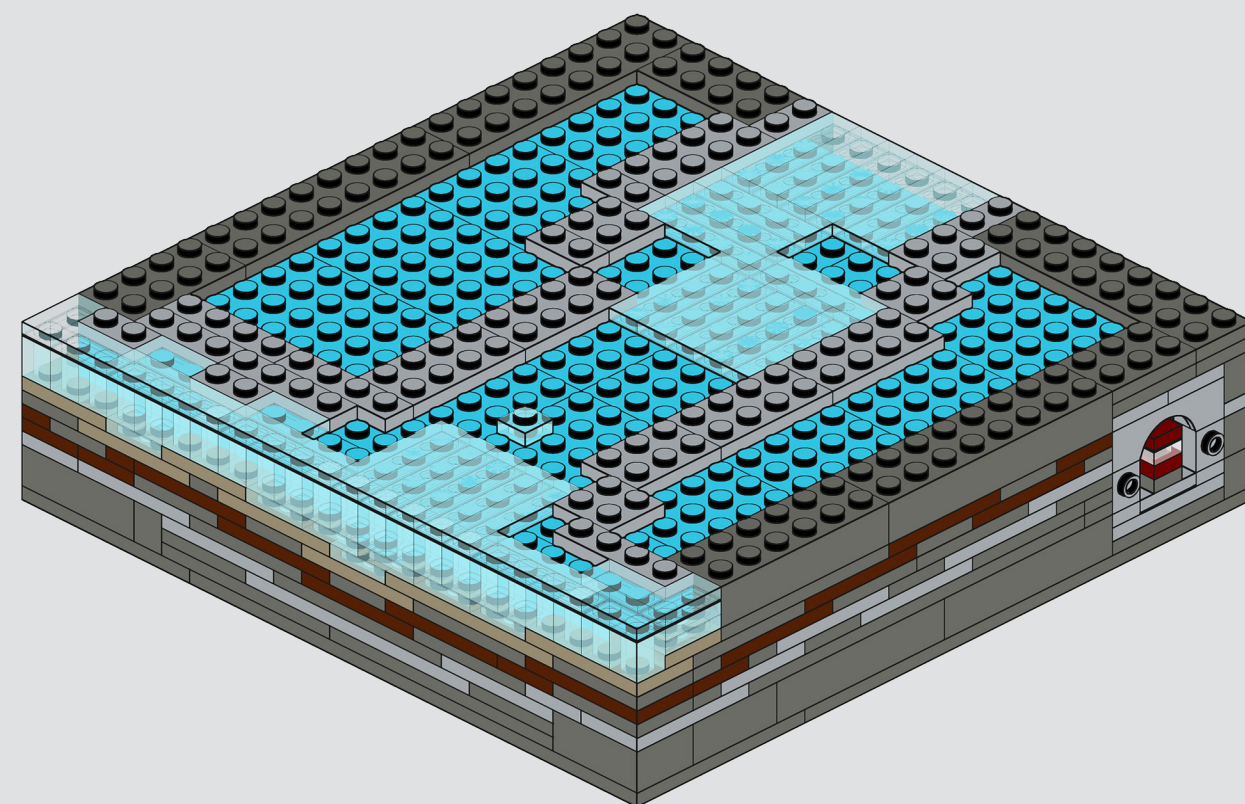
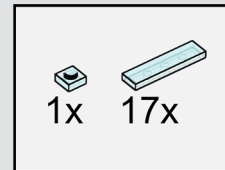

41

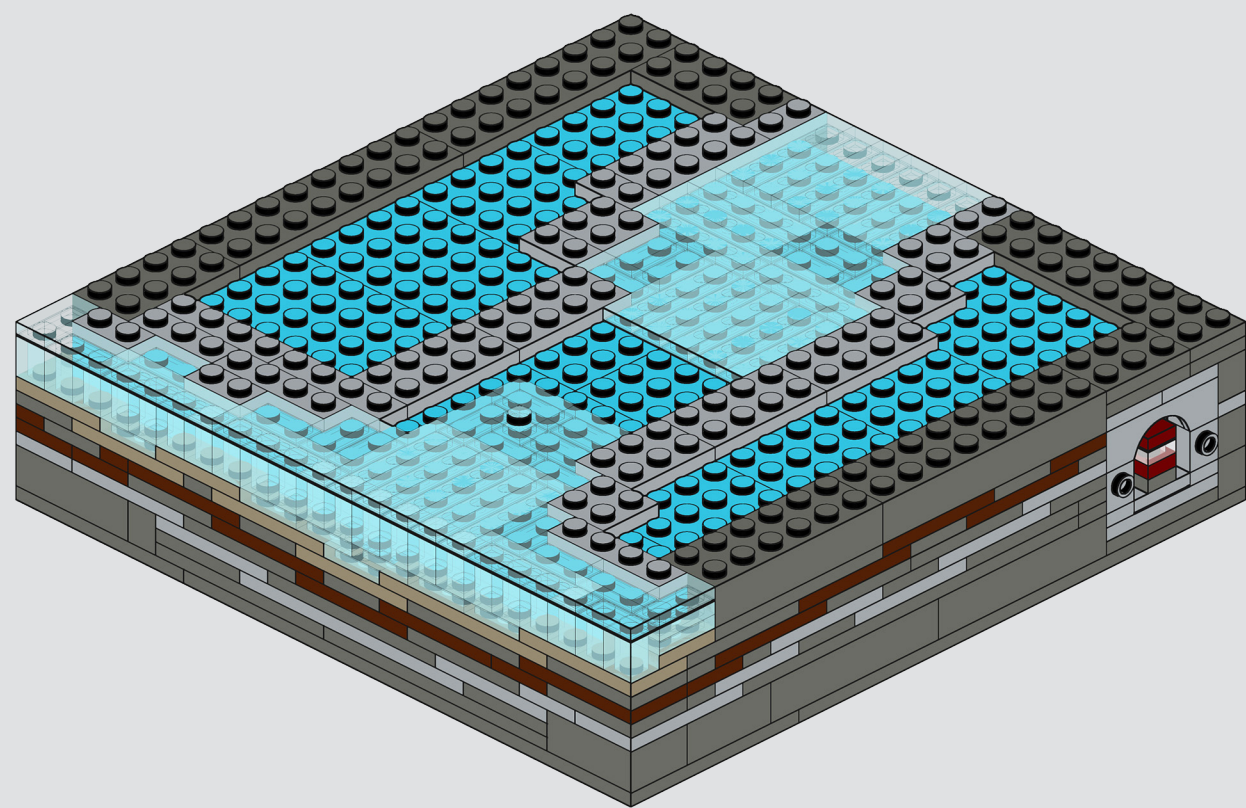
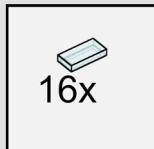

42

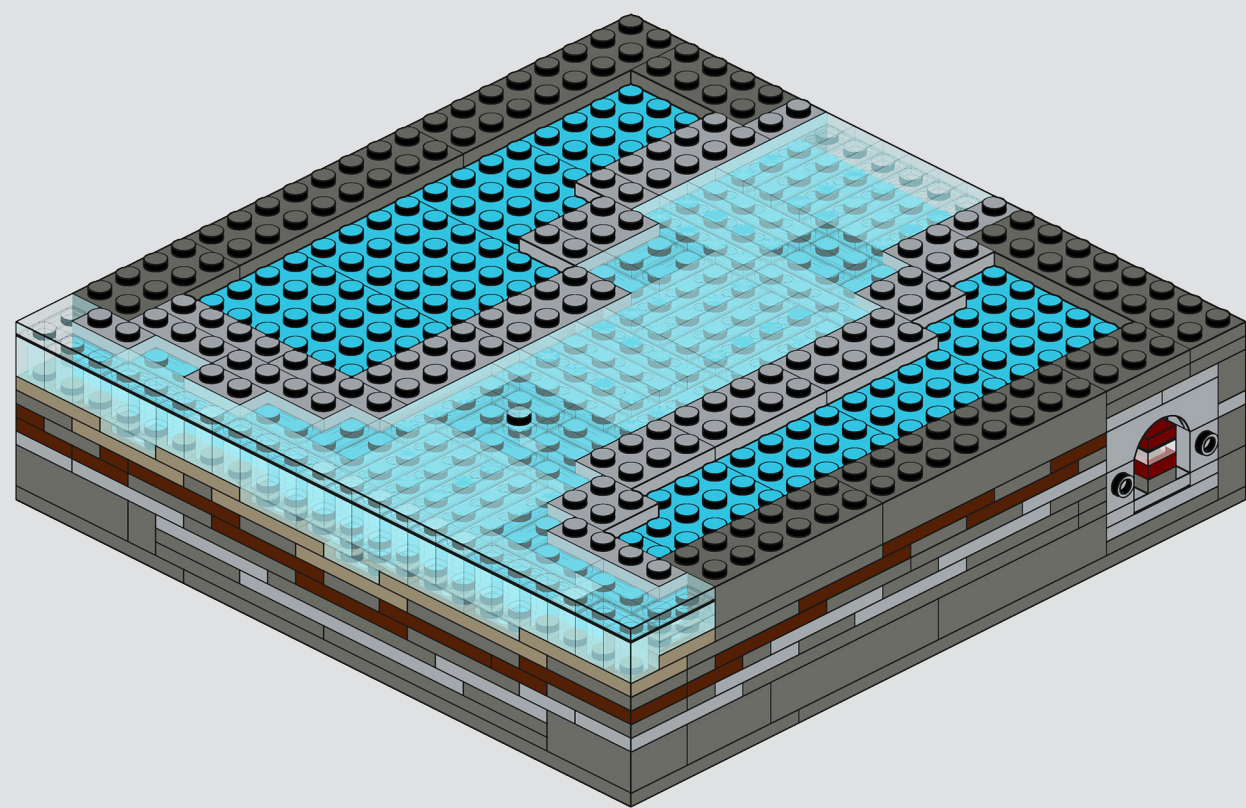
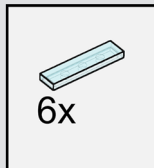

43

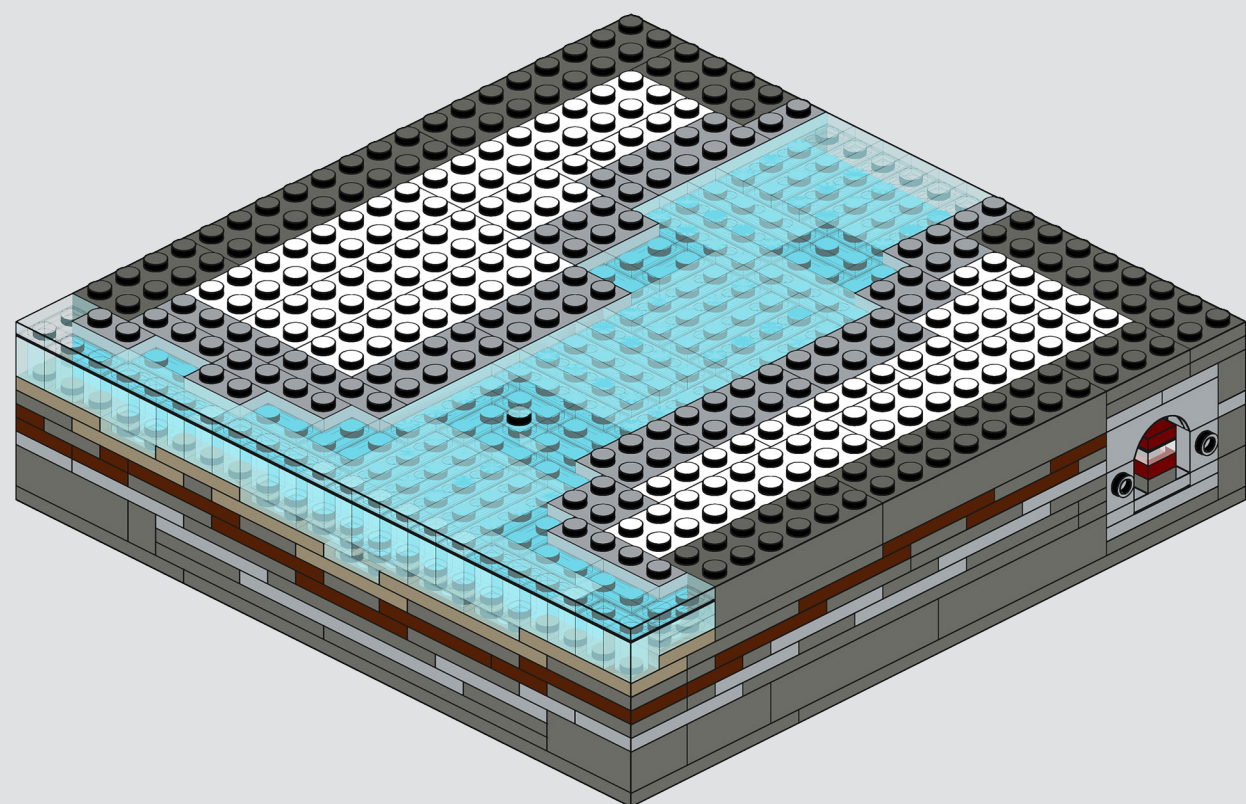
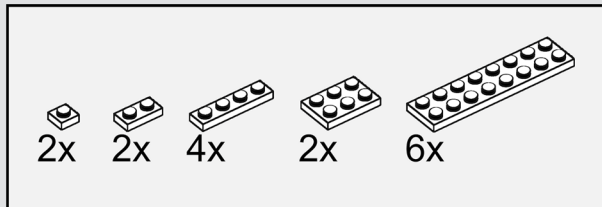

44

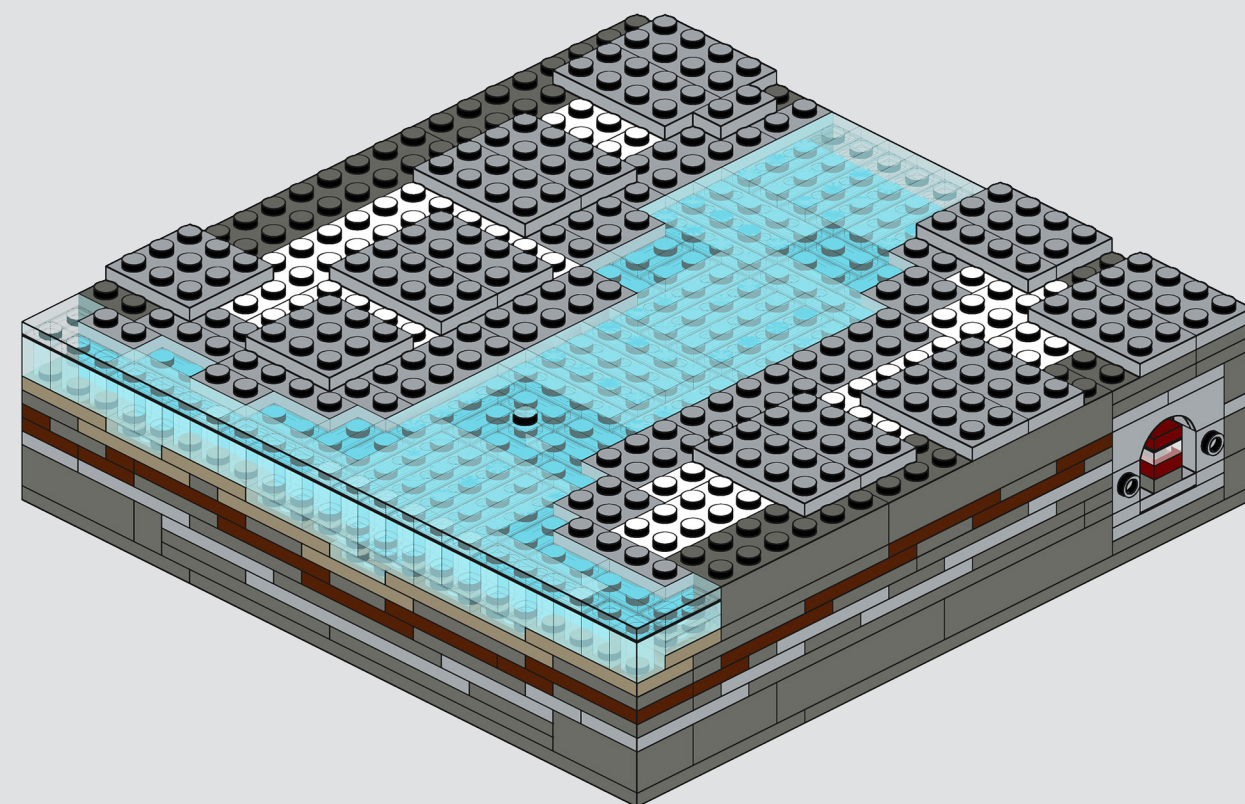
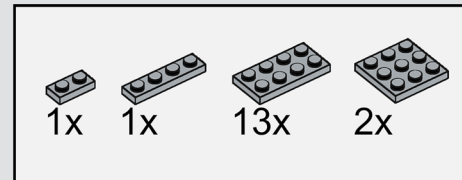

45

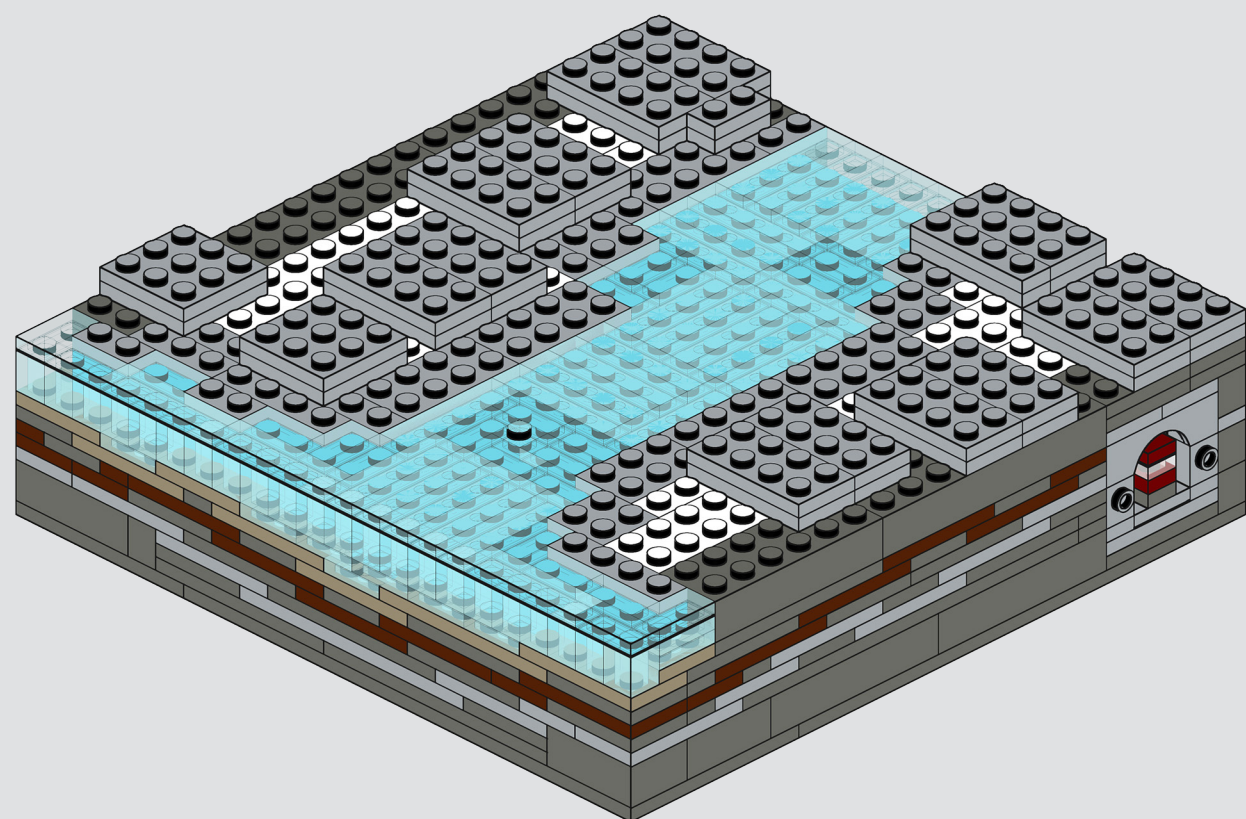
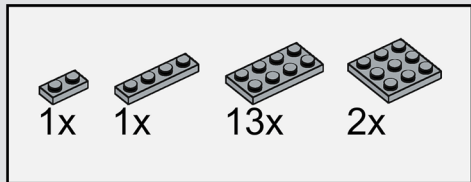

46

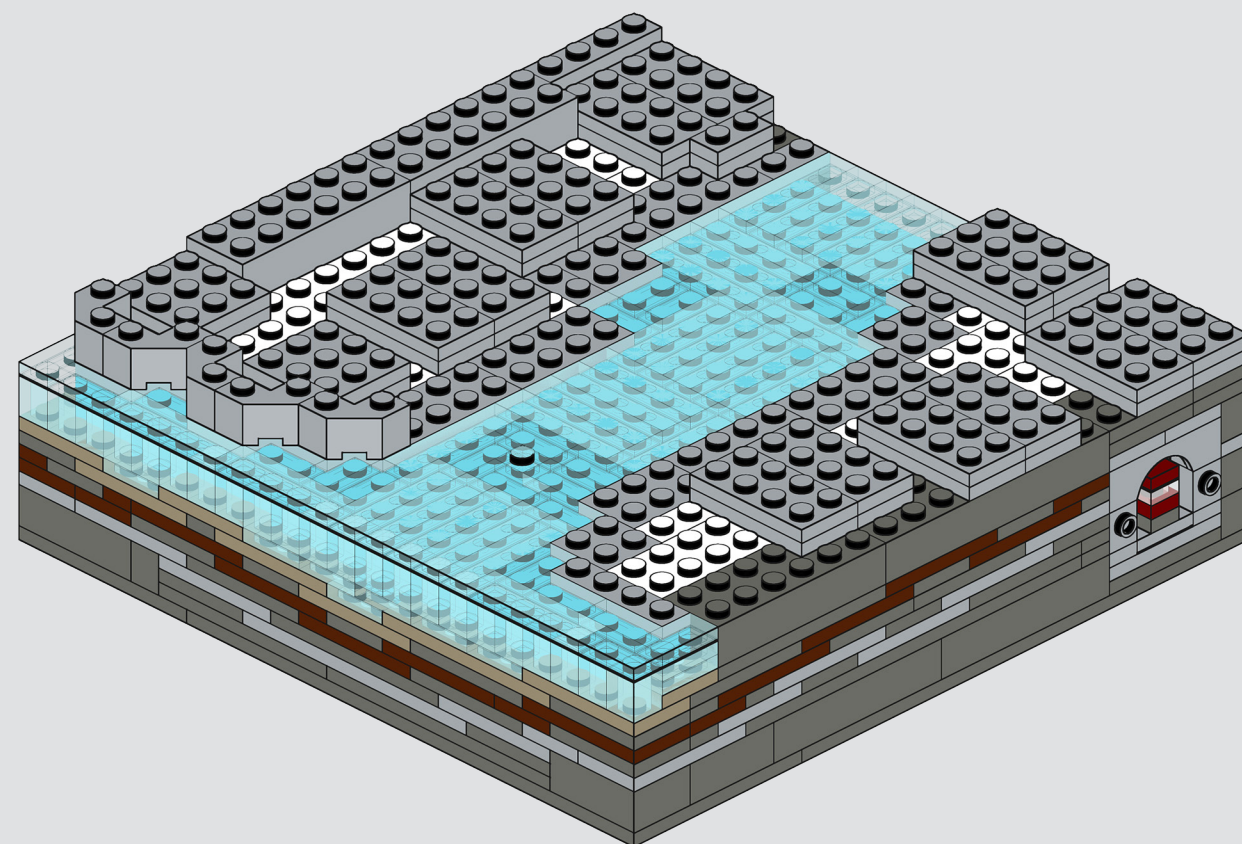
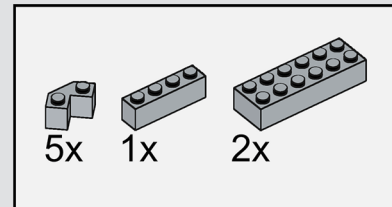

47

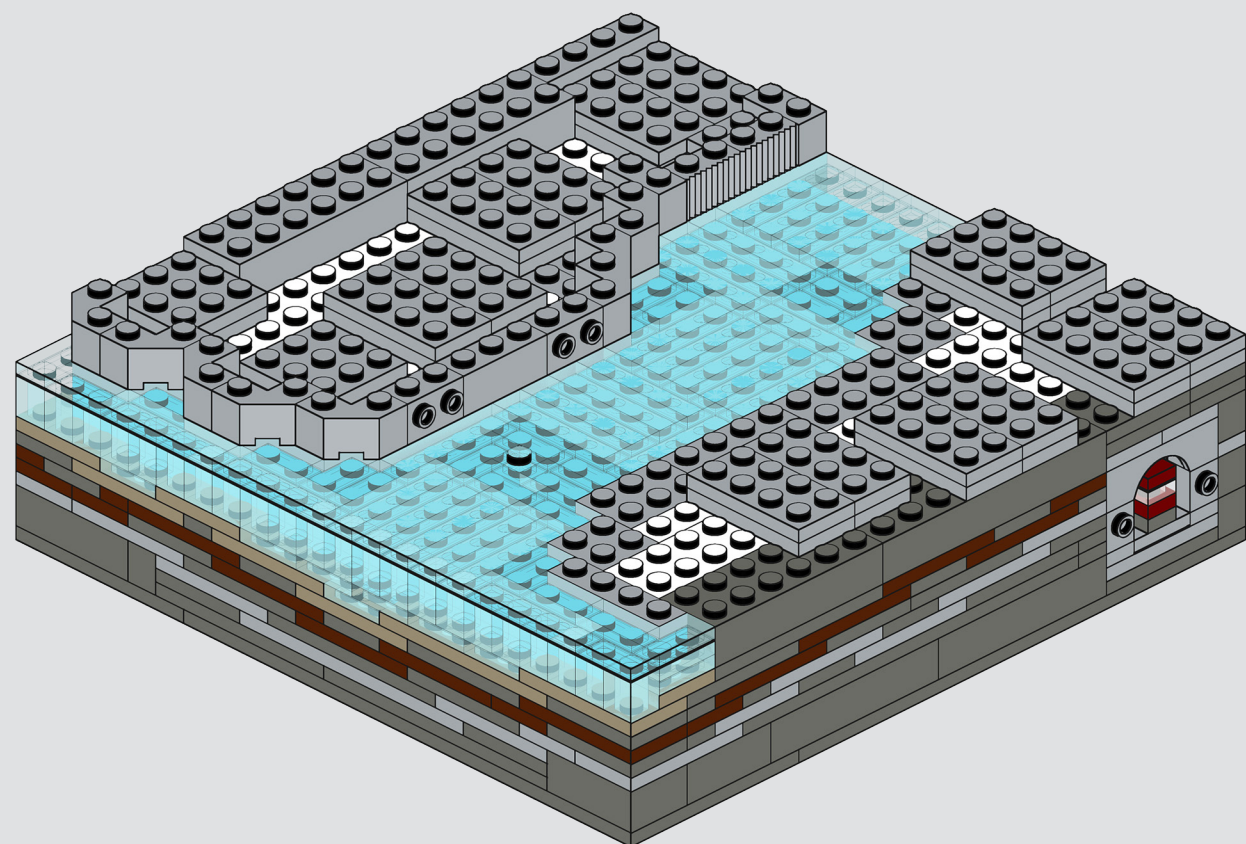
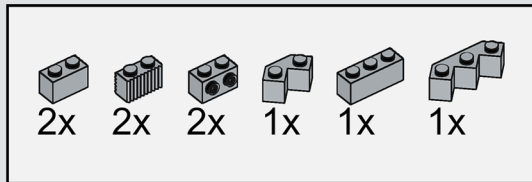

48

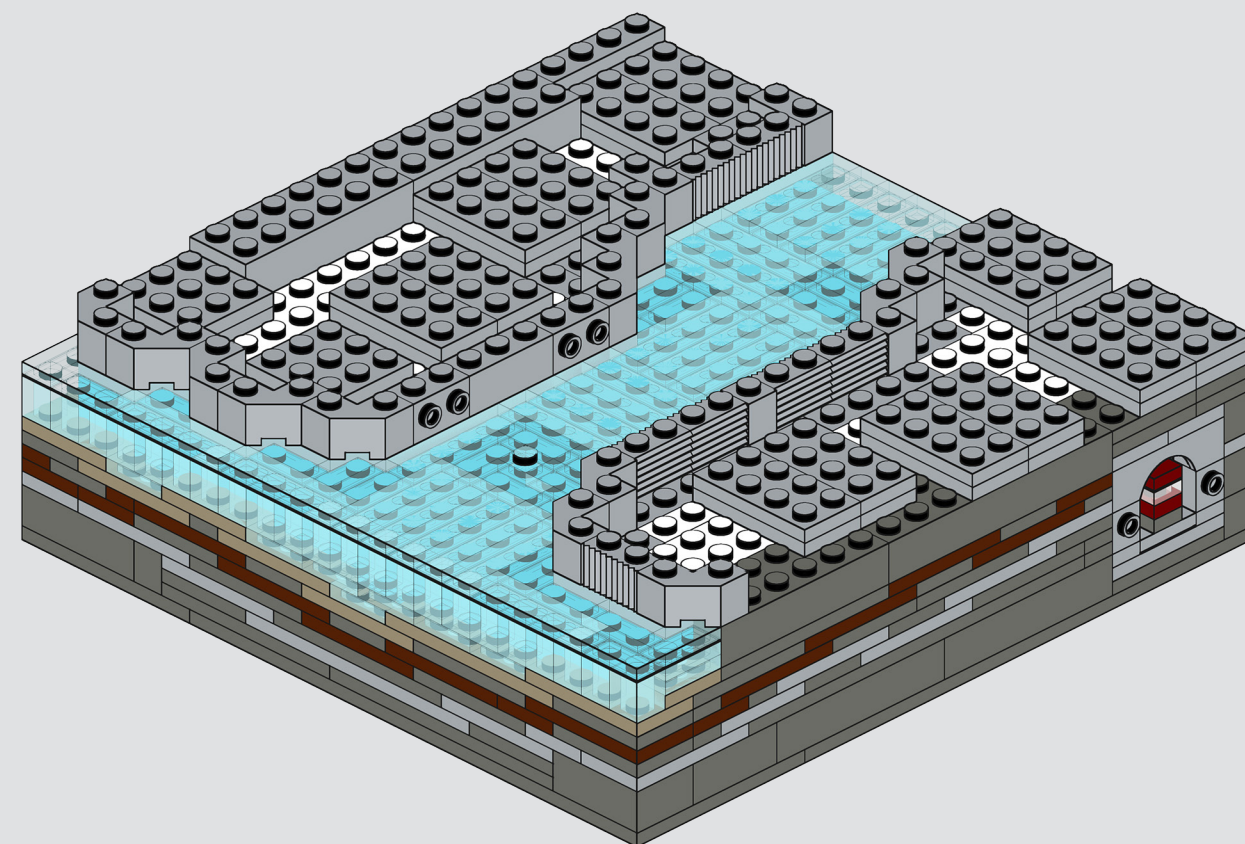
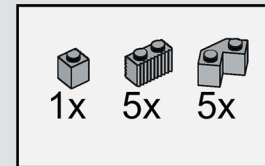

49

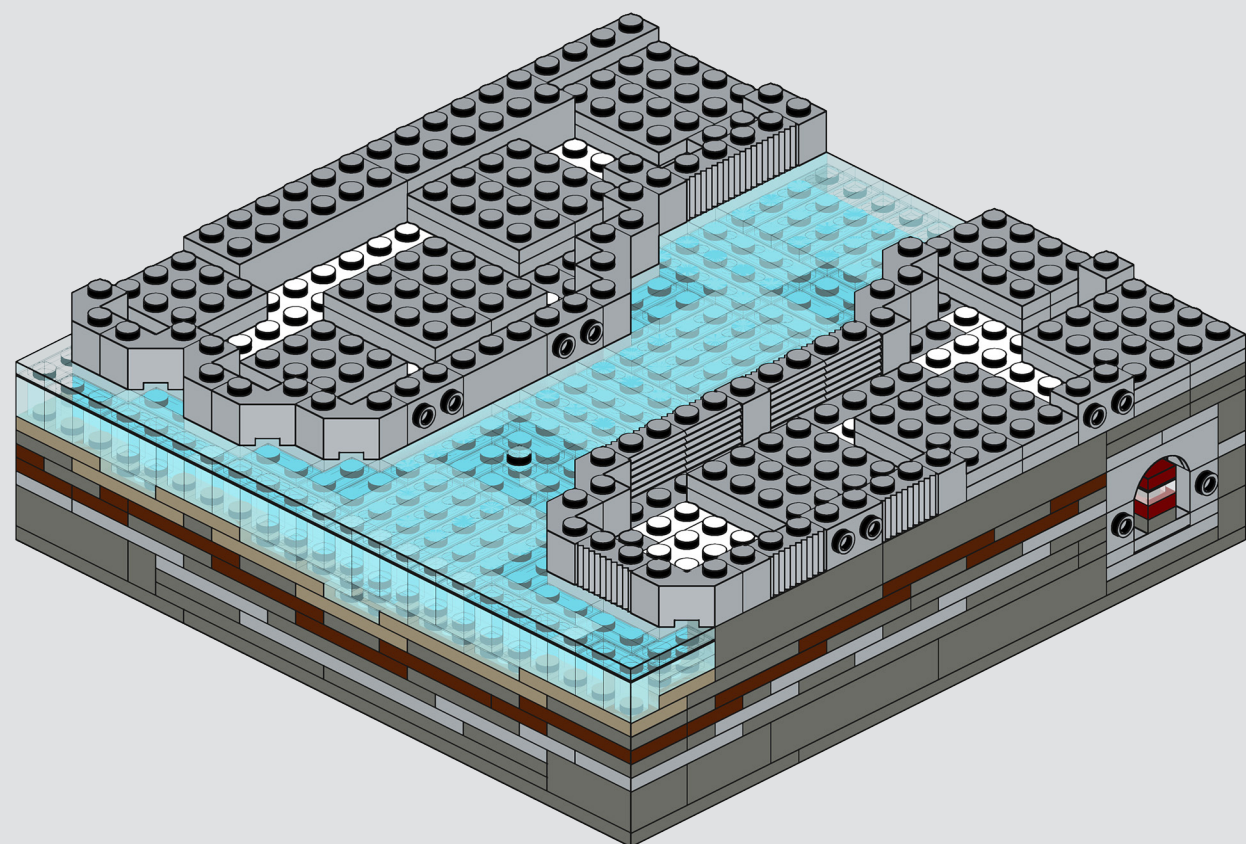
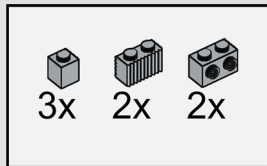

50

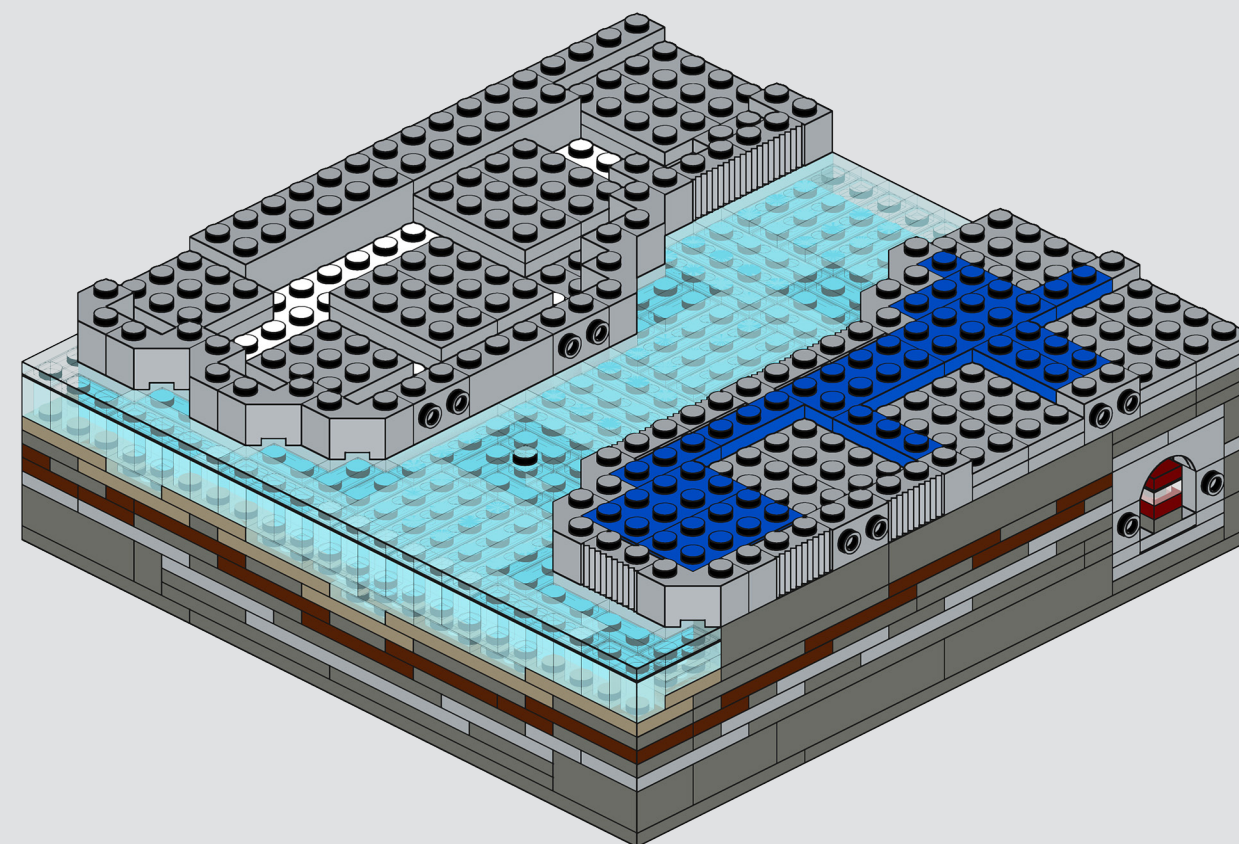
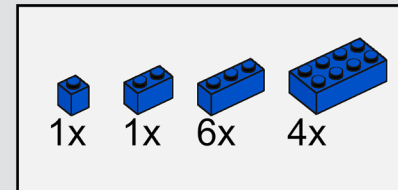

51

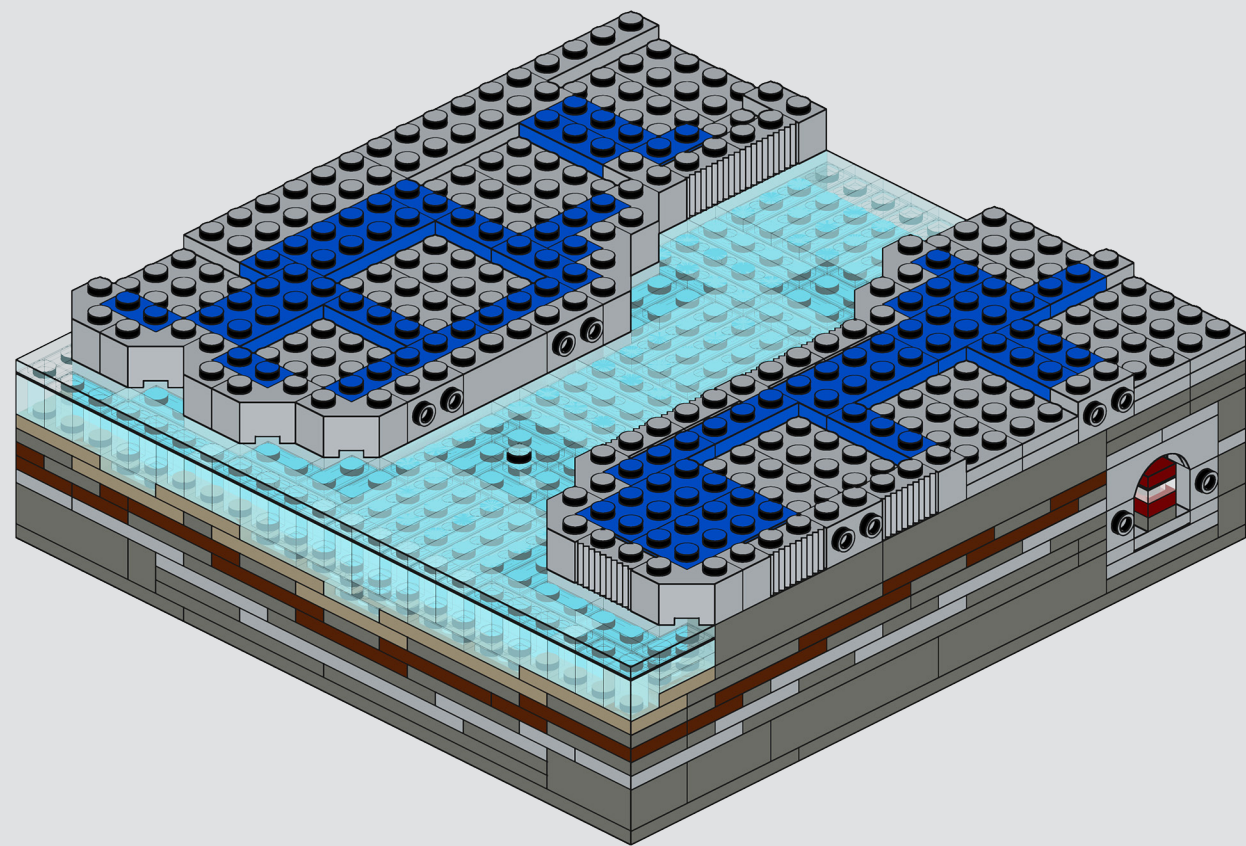
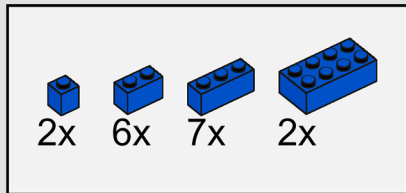

52

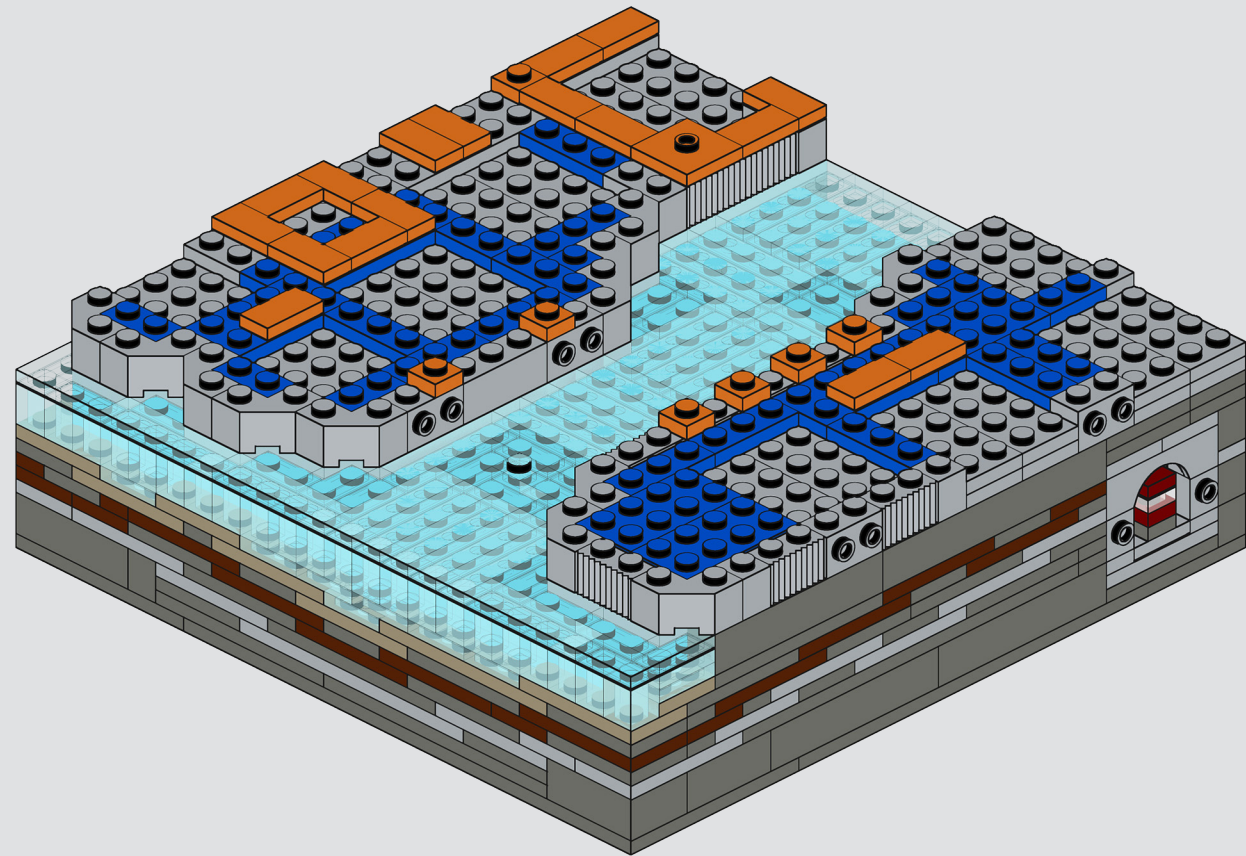
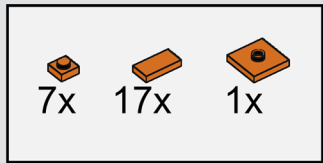

53

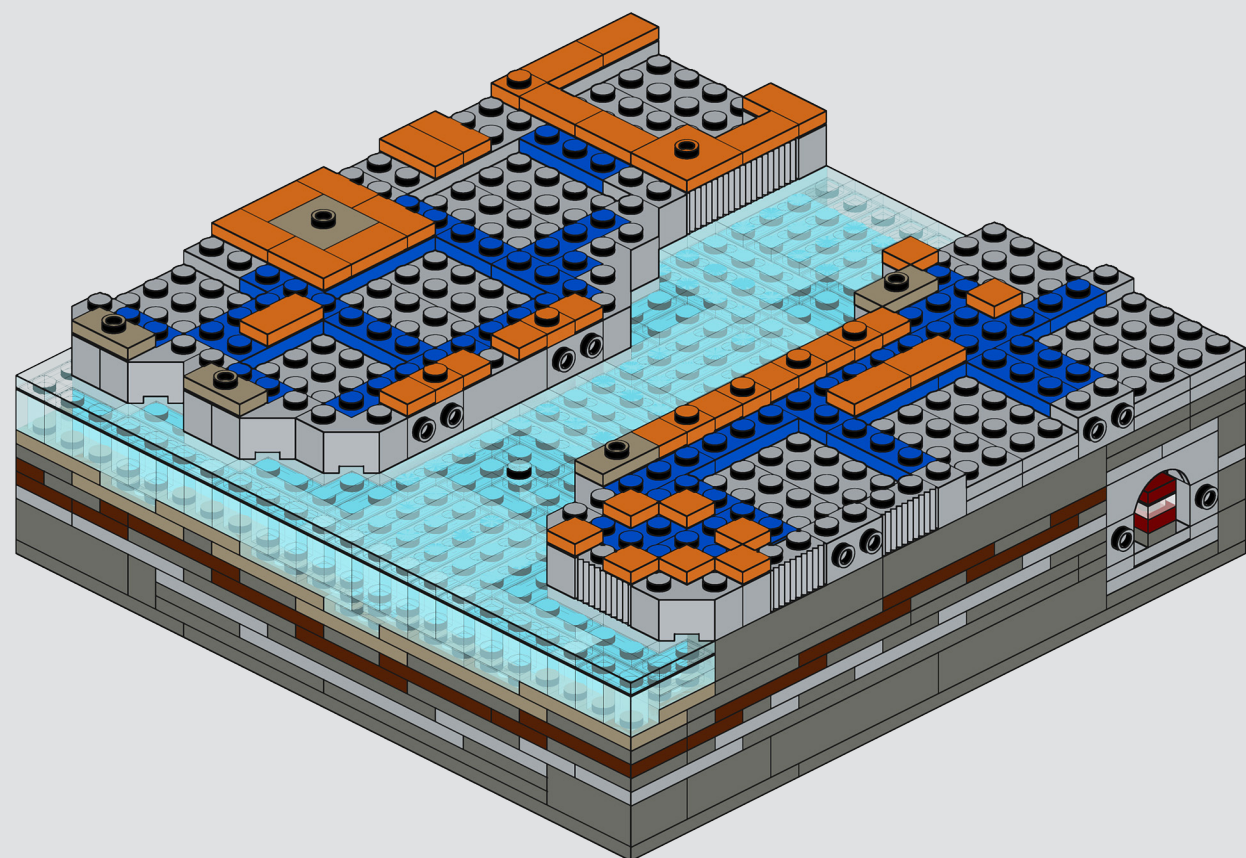
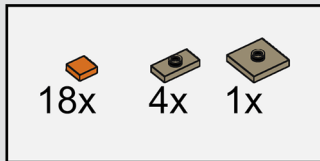

54

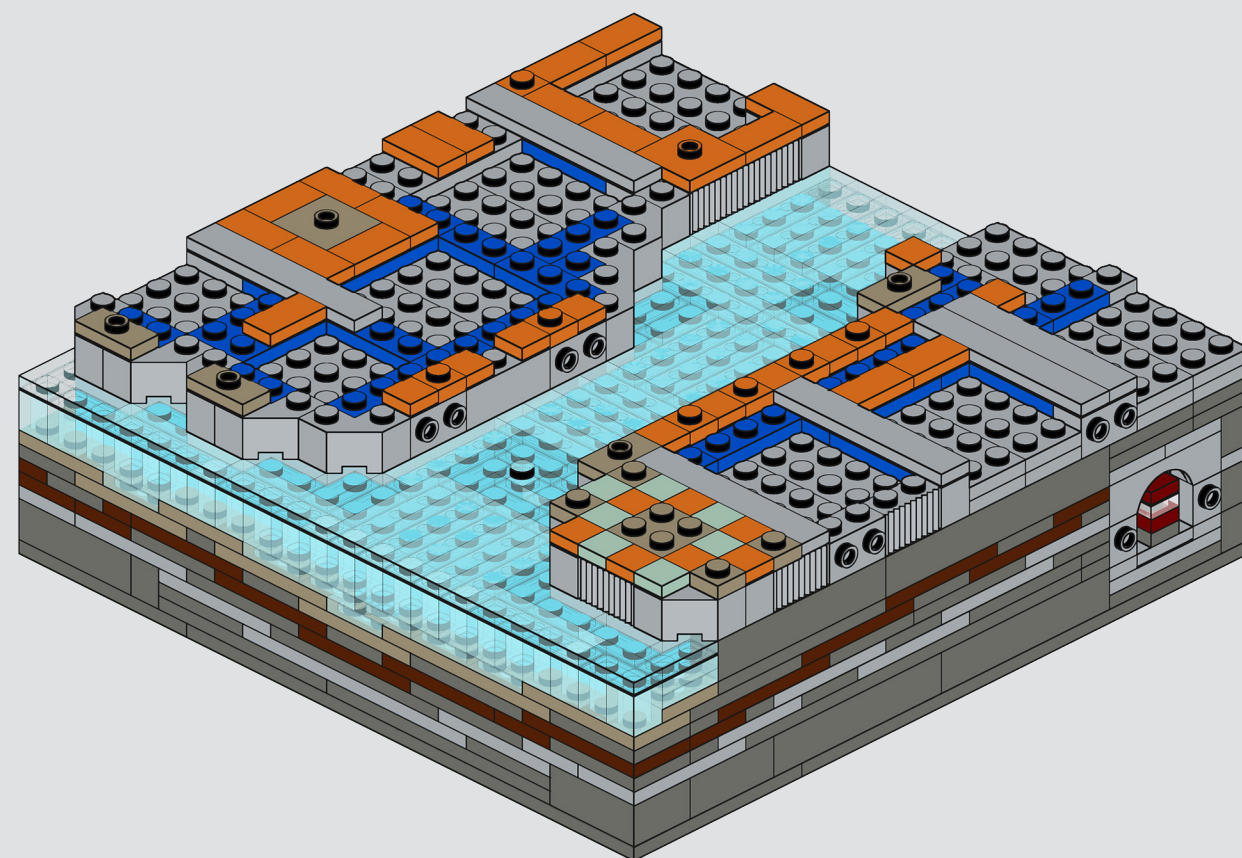
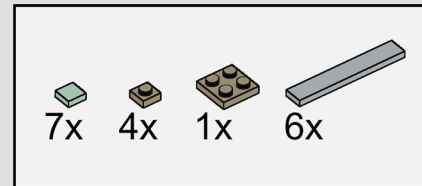

55

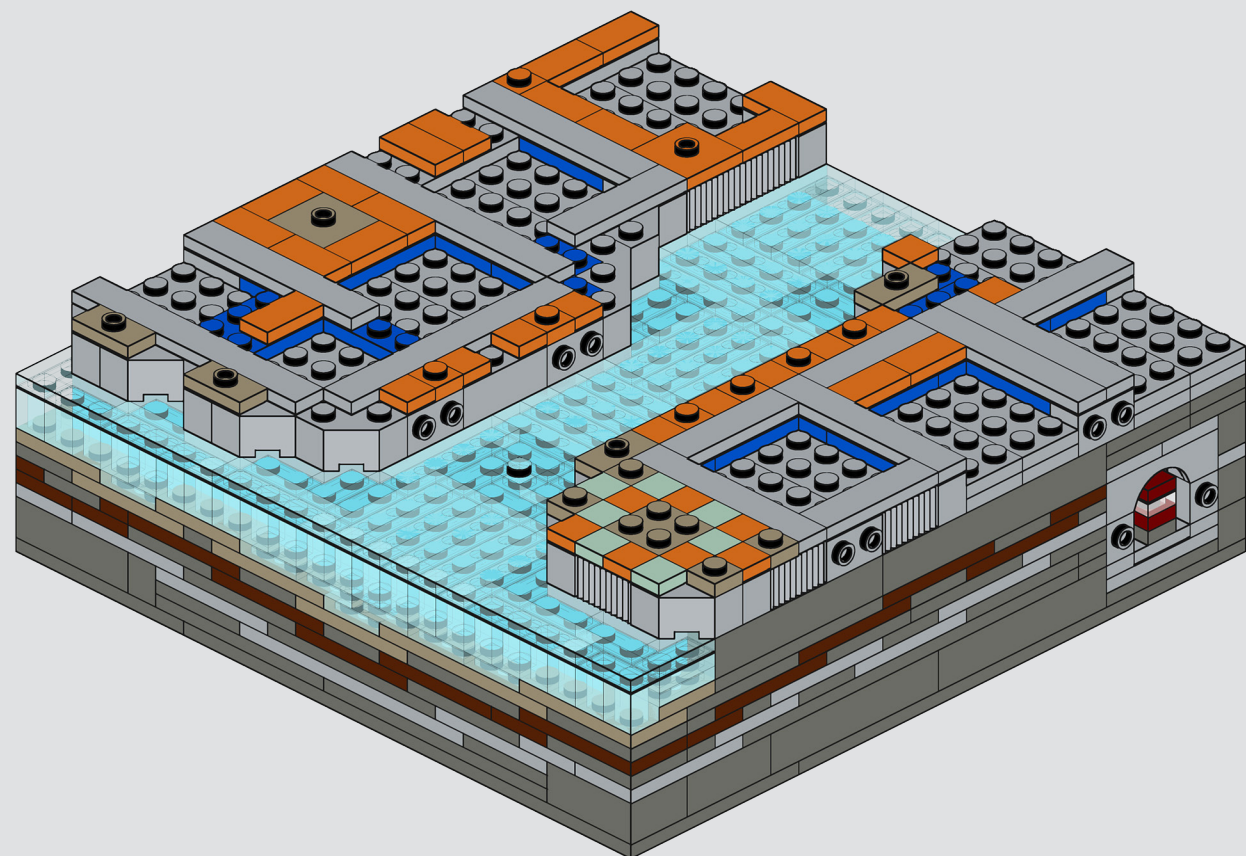
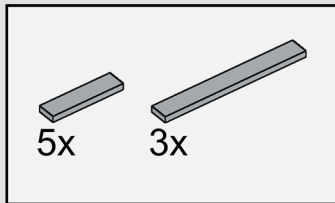

56

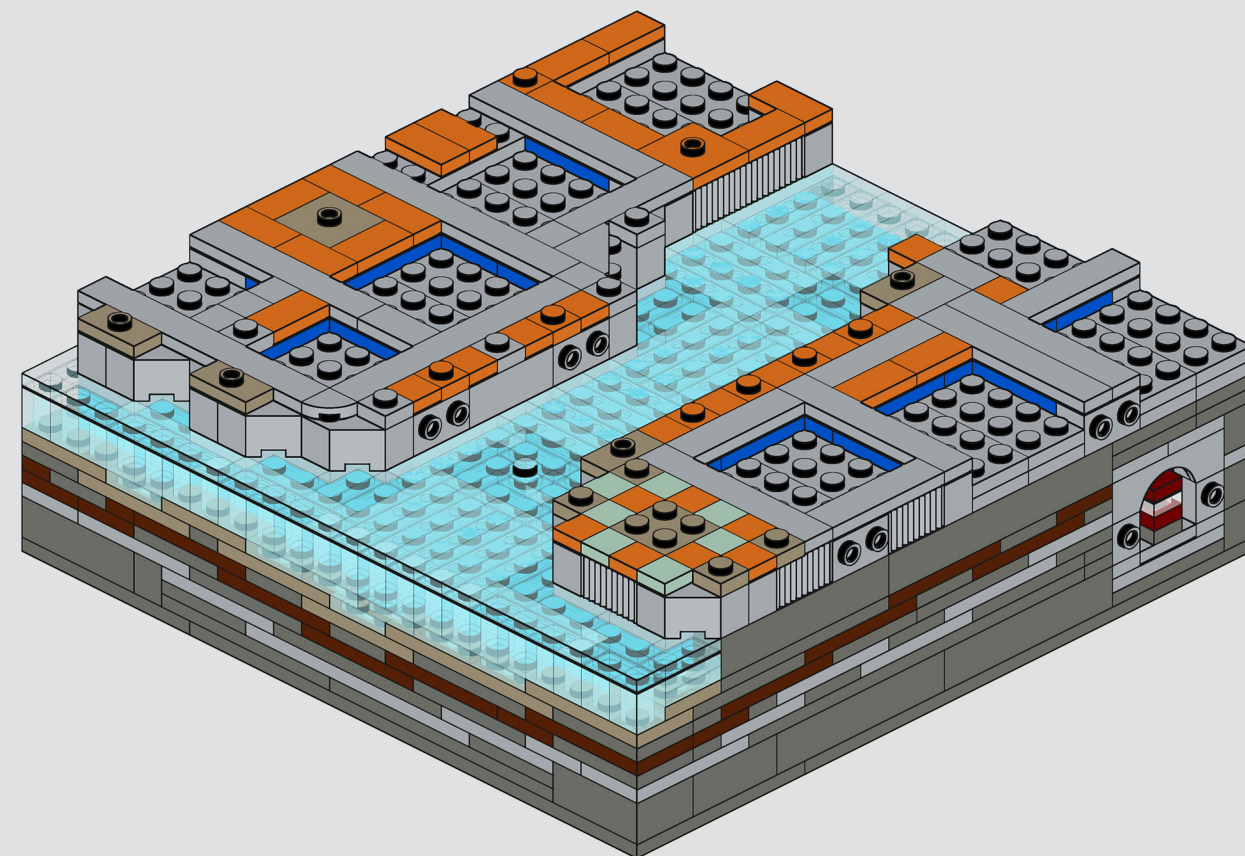
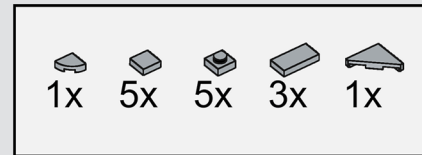

57

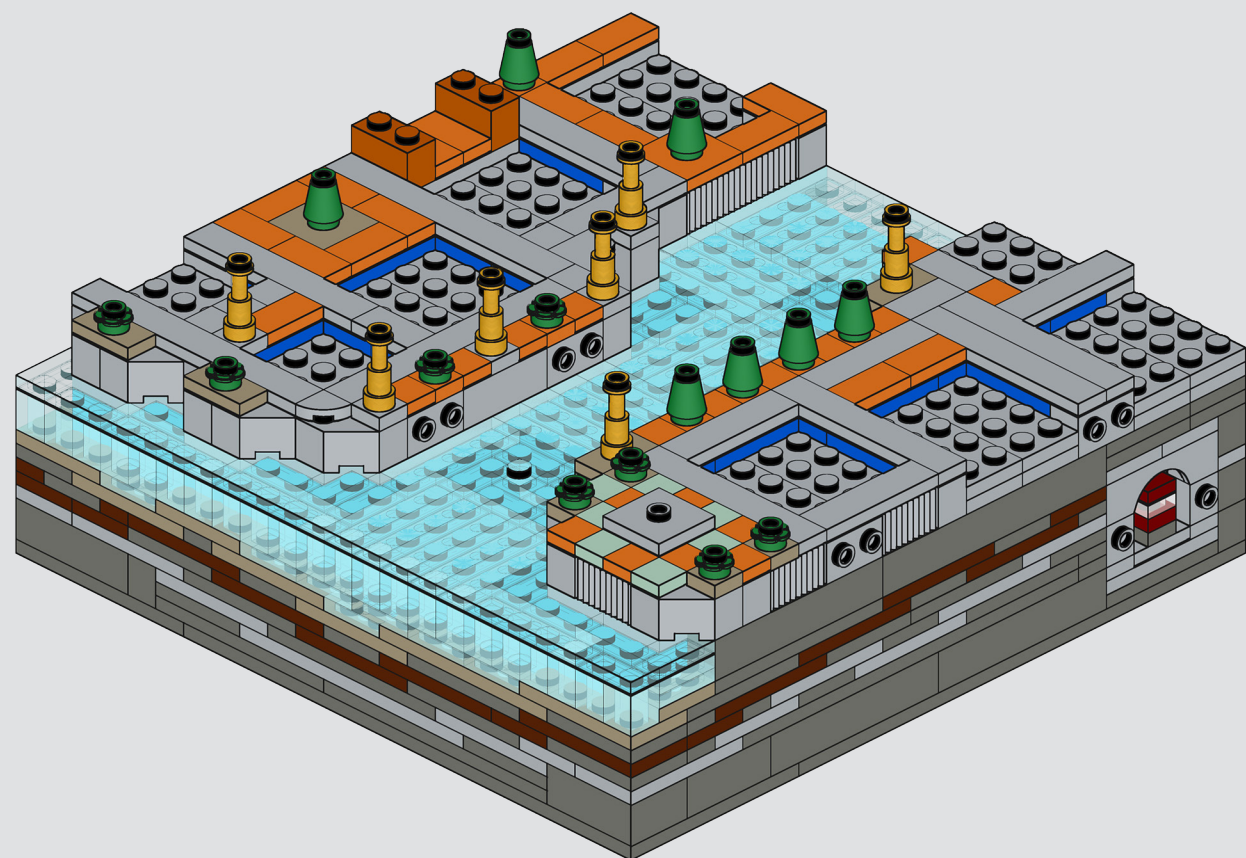
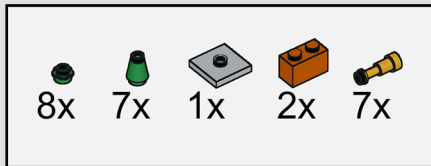

58

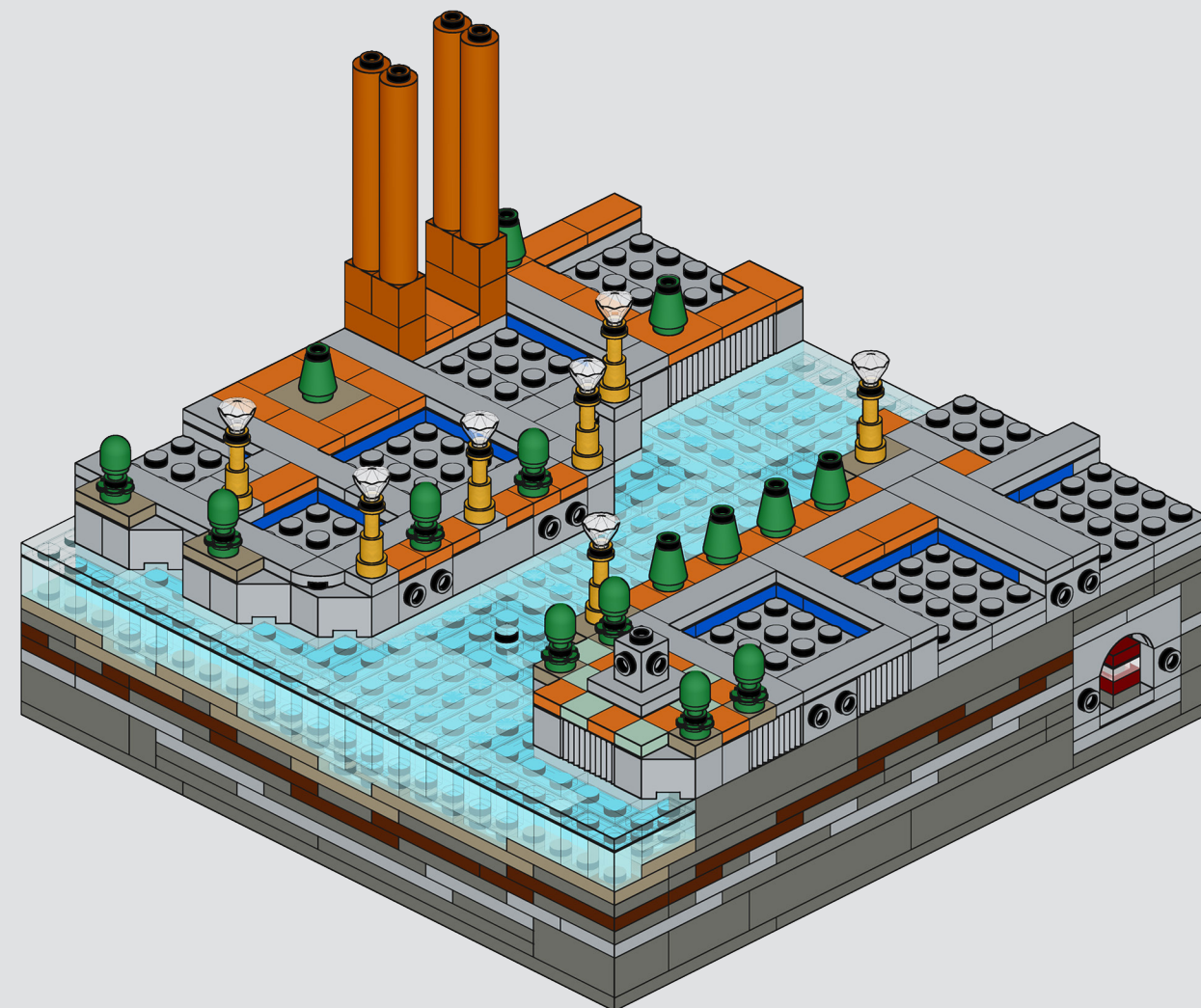
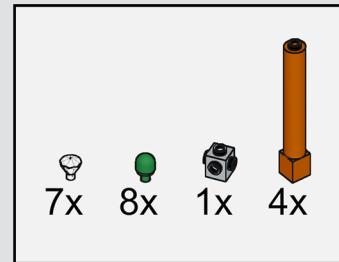

59

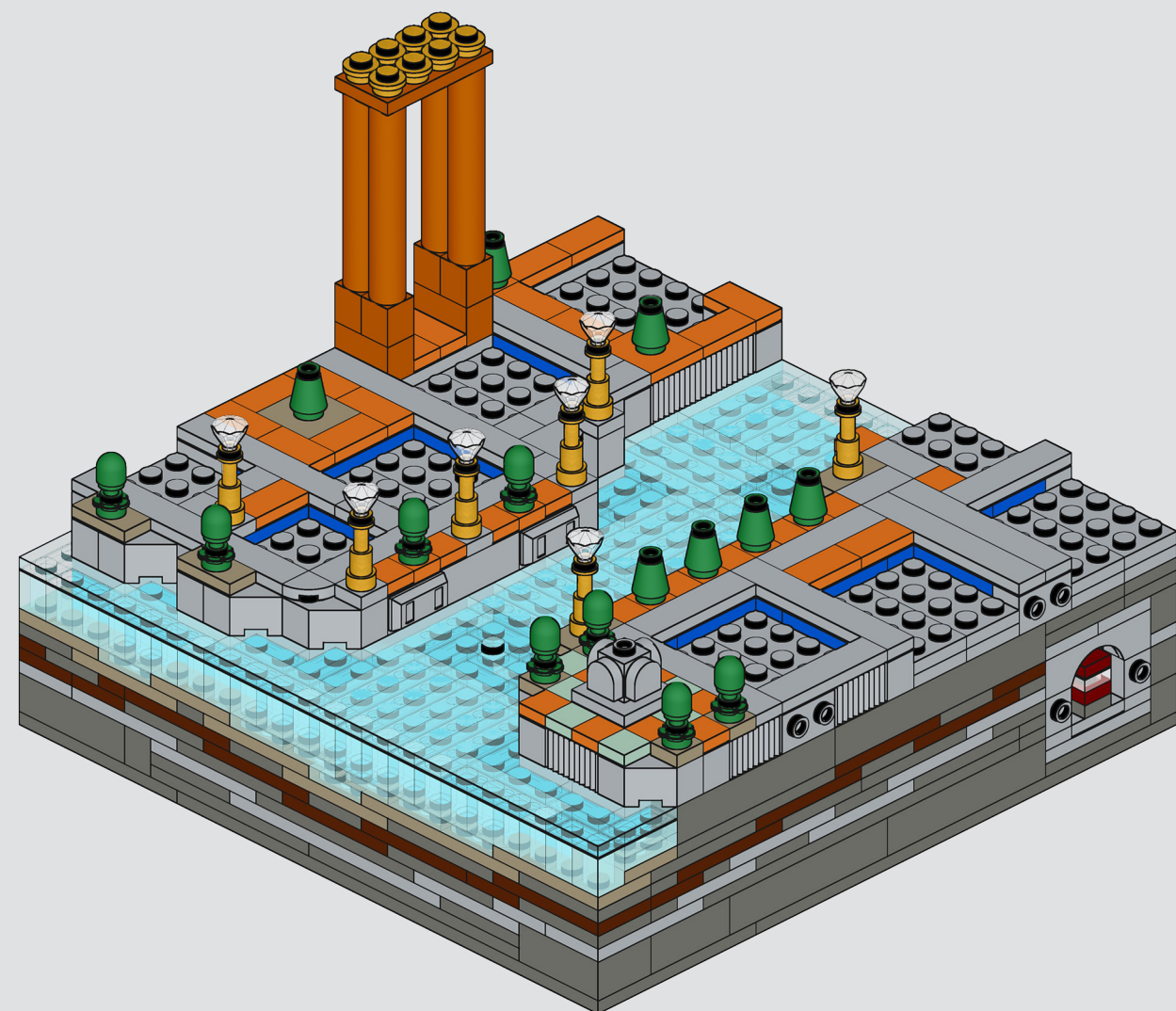
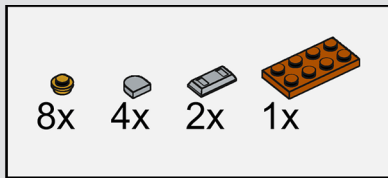

60

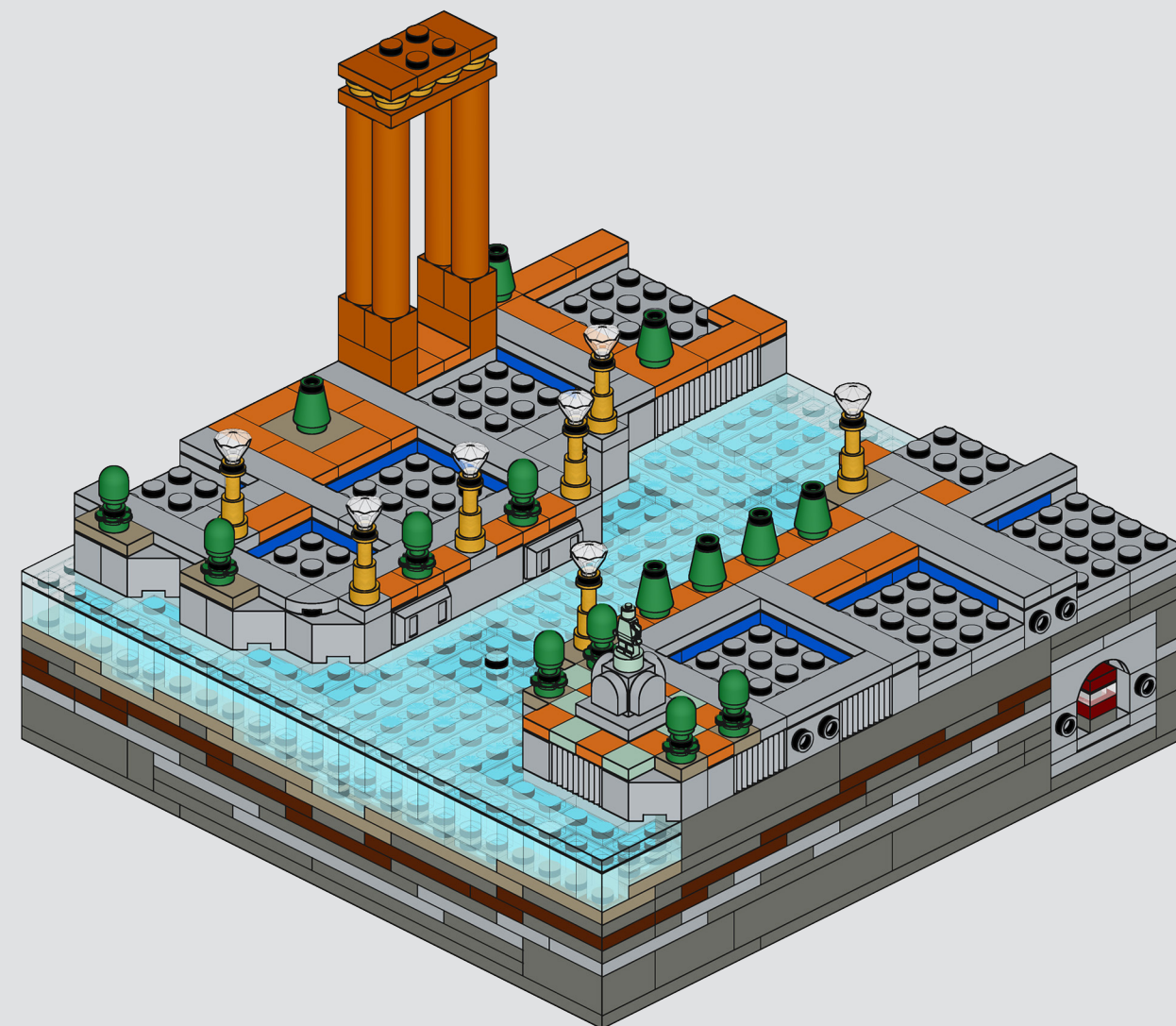
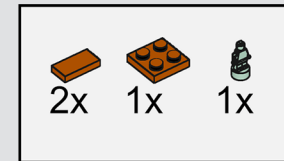

61

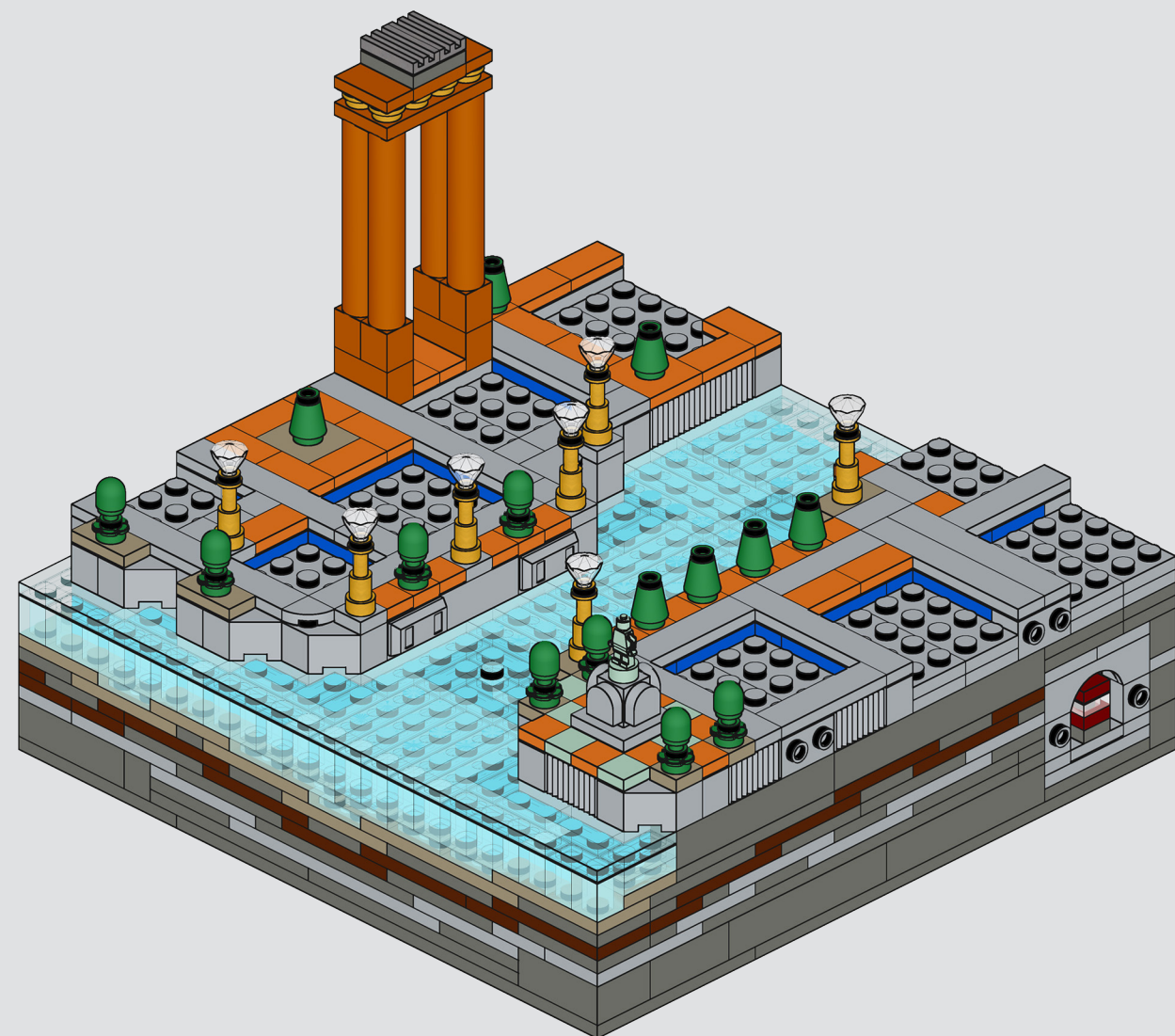
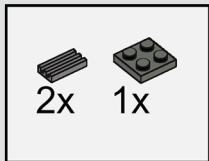

BUILD 11: THE CITY

Gather builds 1–9 along with your base, and get ready for your city to come to life!

